

INGCCO®

Make The World In Your Hands



ALASDAF Trading Est.



**DESIGN
PATENT**



**DESIGNED AND INNOVATED
NEW
BY INCCO
www.ingco.com**

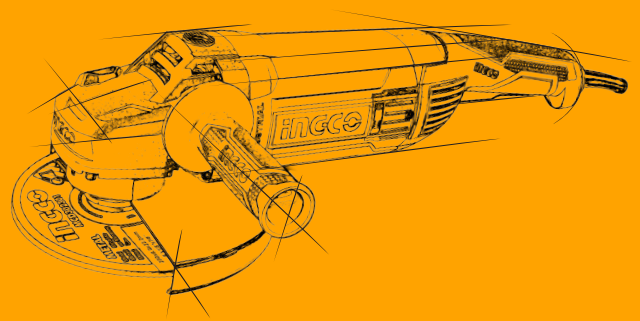
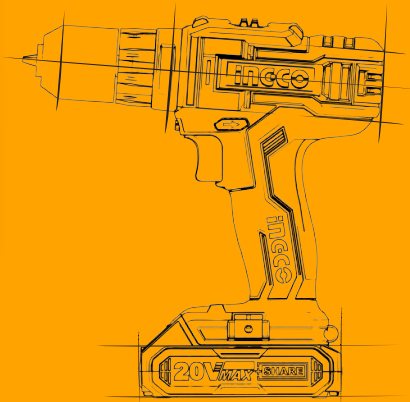

INGCO®

Make The World In Your Hands



**1050W
Rotary hammer**



**20V
Jig saw**



High leverage pliers



**650W
Impact drill**



Screwdriver



Spirit level



**750W
Angle grinder**



Hammer

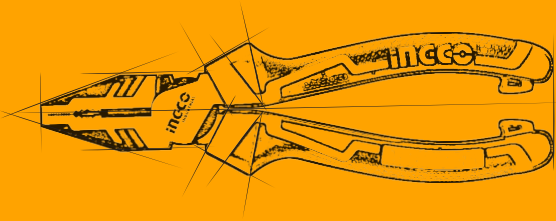

Lithium-ion impact drill

CIDL200215 20V

Voltage:20V
No-load speed:0-400/0-1500rpm
Max impact rate:22500/min
Max torque:45NM
Chuck capacity:0.8-10mm
Torque settings:18+1+1
Mechanical 2-speed gear
Charge volts:220-240V~50/60Hz
Integrated work light
LED battery power indicator
With 2pcs 2.0Ah battery pack (FBLI2001)
With 1pcs charger (FCLI2001E)
With 1pcs Cr-V 65mm bit
With 3pcs masonry drill bits

INDUSTRIAL

| Unit | PACK /QTY | Qty/Ctn |
|------|-----------|---------|
| PCS | | 5 |

Lithium-ion cordless drill

CDLI2002 20V

Voltage:20V
No-load speed:0-400/0-1500rpm
Max torque:45NM
Chuck capacity:0.8-10mm
Torque settings:15+1
Auto-lock keyless chuck
Mechanical 2-speed gear
Spindle lock function
Charge volts:220-240V~50/60Hz
LED battery power indicator
With 2pcs 2.0Ah battery pack (FBLI2001)
With 1pcs charger (FCLI2001E)
With 47pcs accessories

INDUSTRIAL

| Unit | PACK /QTY | Qty/Ctn |
|------|-----------|---------|
| PCS | | 5 |

Lithium-ion impact drill

CIDL2002 20V

Voltage:20V
No-load speed:0-400/0-1500rpm
Max impact rate:22500/min
Max torque:45NM
Chuck capacity:0.8-10mm
Torque settings:18+1+1
Auto-lock keyless chuck
Mechanical 2-speed gear
Charge volts:220-240V~50/60Hz
Integrated work light
LED battery power indicator
With 2pcs battery pack (FBLI2001)
With 1pcs charger (FCLI2001E)
With 50pcs accessories

INDUSTRIAL

| Unit | PACK /QTY | Qty/Ctn |
|------|-----------|---------|
| PCS | | 5 |

Lithium-ion impact wrench

CIWLI2001 20V

Brushless motor
Voltage:20V
Square drive:1/2"
No-load speed:0-1300/0-2100rpm
Impact rate:0-2000/0-3300bpm
Max torque:300NM
With 2pcs 2.0Ah battery pack(FBLI2001)
With 1pcs charger(FCLI2001E)
Charge volts:220-240V~50/60Hz
Integrated work light
LED battery power indicator
With 3pcs sockets(17 19 21mm)
Packed by canvas bag

INDUSTRIAL

| Unit | PACK /QTY | Qty/Ctn |
|------|-----------|---------|
| PCS | | 5 |

Lithium-ion battery pack

FBLI20011 2.0Ah

Voltage:20V
Lithium-ion 2.0Ah battery
LED battery power indicator
One battery fits all P20S multiple tools
Packed by color box

INDUSTRIAL

| Unit | PACK /QTY | Qty/Ctn |
|------|-----------|---------|
| PCS | | 20 |

Lithium-ion battery pack

FBLI2002 4.0Ah

Voltage:20V
Lithium-ion 4.0Ah battery
LED battery power indicator
One battery fits all P20S multiple tools
Packed by color box

INDUSTRIAL

| Unit | PACK /QTY | Qty/Ctn |
|------|-----------|---------|
| PCS | | 12 |

Fast intelligent charger

FCLI2001-8 20V

Input voltage:220-240V~50/60Hz(BS Plug)
Output voltage:20V
Output current:2A
Packed by color box

INDUSTRIAL

| Unit | PACK /QTY | Qty/Ctn |
|------|-----------|---------|
| PCS | | 20 |

Lithium-ion angle grinder

CAGLI201158 20V

Brushless Motor
Voltage:20V
No-load speed:3000/8500rpm
Disc diameter:115mm
Spindle thread:M14
Battery and charger sold separately
Disc not included
Packed by color box

INDUSTRIAL

Battery and charger sold separately

INDUSTRIAL

| Unit | PACK /QTY | Qty/Ctn |
|------|-----------|---------|
| PCS | | 6 |

Lithium-ion angle grinder

CAGLI2011582 20V

Brushless Motor
Voltage:20V
No-load speed:3000/8500rpm
Disc diameter:115mm
Spindle thread:M14
Charge volts:220-240V~50/60Hz
With 2pcs 4.0Ah battery pack (FBLI2002)
With 1pcs charger (FCLI2001E)
With 1set abrasive metal cutting disc set
Packed by canvas bag

INDUSTRIAL

| Unit | PACK /QTY | Qty/Ctn |
|------|-----------|---------|
| PCS | | 6 |

Lithium-ion blower

CABLI200181 20V

Voltage:20V
No-load speed:0-9000/0-18000rpm
Max air volume:2.7m³/min
Charge volts:220-240V~50/60Hz
With 1pcs 2.0Ah battery pack(FBLI20011)
With 1pcs charger (FCLI2001)
Packed by color box

INDUSTRIAL

| Unit | PACK /QTY | Qty/Ctn |
|------|-----------|---------|
| PCS | | 4 |

Impact drill

| | |
|---------------|-------------|
| ID6808 | 680W |
|---------------|-------------|

Voltage:220-240V~50/60Hz
 Input power:680W
 No-load speed:0-3000rpm
 Max.drilling capacity:13mm
 Variable speed control
 Forward/Reverse switch
 Hammer function
 Packed by color box



680W

X5PCS **SUPER SELECT**

| Unit | PACK /QTY | Qty/Ctn |
|------|-----------|---------|
| PCS | | 10 |

Impact drill

| | |
|---------------|-------------|
| ID8508 | 850W |
|---------------|-------------|

Voltage: 220-240V~50/60Hz
 Input power: 850W
 No-load speed:0-2700rpm
 Max.drilling capacity:13mm
 Variable speed control
 Forward/Reverse switch
 Hammer function
 With 1set extra carbon brushes
 Packed by color box



850W

INDUSTRIAL

| Unit | PACK /QTY | Qty/Ctn |
|------|-----------|---------|
| PCS | | 5 |

Impact drill

| | |
|----------------|--------------|
| ID11008 | 1010W |
|----------------|--------------|

Voltage:220-240V~50/60Hz
 Input power:1100W
 No-load speed:0-2800rpm
 Max.drilling capacity:13mm
 Variable speed control
 Forward/Reverse switch
 Hammer function
 Aluminum gear box
 With 1set extra carbon brushes
 Packed by color box



1100W

INDUSTRIAL

| Unit | PACK /QTY | Qty/Ctn |
|------|-----------|---------|
| PCS | | 5 |

Electric drill

| | |
|----------------|-------------|
| ED50028 | 500W |
|----------------|-------------|

Voltage:220-240V~50/60Hz
 Input power:500W
 No-load speed:0-3300rpm
 Max.drilling capacity:10mm
 Variable speed control
 Forward/Reverse switch
 With 1set extra carbon brushes
 Packed by color box



500W

INDUSTRIAL

| Unit | PACK /QTY | Qty/Ctn |
|------|-----------|---------|
| PCS | | 5 |

Mixer

| | |
|-----------------|--------------|
| MX214008 | 1400W |
|-----------------|--------------|

Voltage:220-240V~50/60Hz
 Input power:1400W
 No-load speed:0-500rpm/0-750rpm
 Mixing pad thread:M14
 Aluminum gear box
 Integrated work light
 With 1pcs mixing pad
 With 1set extra carbon brushes
 Packed by color box



1400W

INDUSTRIAL

| Unit | PACK /QTY | Qty/Ctn |
|------|-----------|---------|
| PCS | | 2 |

Angle grinder

| | |
|----------------|-------------|
| AG75028 | 750W |
|----------------|-------------|

Voltage:220-240V~50/60Hz
 Input power:750W
 No-load speed:12000rpm
 Disc diameter:115mm
 Spindle thread:M14
 With 1pcs auxiliary handle
 Disc not included
 Packed by color box



750W

Ø115mm

INDUSTRIAL

SUPER SELECT

| Unit | PACK /QTY | Qty/Ctn |
|------|-----------|---------|
| PCS | | 10 |

Angle grinder

| | |
|----------------|-------------|
| AG90028 | 900W |
|----------------|-------------|

Voltage:220-240V~50/60Hz
 Input power:900W
 No-load speed:11000rpm
 Disc diameter:125mm
 Spindle thread:M14
 With 1pcs auxiliary handle
 Disc not included
 Packed by color box



900W

Ø125mm

INDUSTRIAL

| Unit | PACK /QTY | Qty/Ctn |
|------|-----------|---------|
| PCS | | 6 |

Angle grinder

| | |
|----------------|-------------|
| AG95018 | 950W |
|----------------|-------------|

Voltage:220-240V~50/60Hz
 Input power:950W
 No-load speed:11000rpm
 Disc diameter:115mm
 Spindle thread:M14
 With 1pcs auxiliary handle
 With 1set extra carbon brushes
 Disc not included
 Packed by color box



950W

Ø115mm

INDUSTRIAL

| Unit | PACK /QTY | Qty/Ctn |
|------|-----------|---------|
| PCS | | 6 |

Angle grinder

| | |
|-----------------|--------------|
| AG110018 | 1100W |
|-----------------|--------------|

Voltage:220-240V~50/60Hz
 Input power:1100W
 No-load speed:11000rpm
 Disc diameter:125mm
 Spindle thread:M14
 With 1pcs auxiliary handle
 With 1set extra carbon brushes
 Disc not included
 Packed by color box



1100W

Ø125mm

INDUSTRIAL

| Unit | PACK /QTY | Qty/Ctn |
|------|-----------|---------|
| PCS | | 6 |

Angle grinder

| | |
|-----------------|--------------|
| AG200018 | 2000W |
|-----------------|--------------|

Voltage:220-240V~50/60Hz
 Input power:2000W
 No-load speed:8450rpm
 Disc diameter:180mm
 Spindle thread:M14
 With 1pcs auxiliary handle
 With 1set extra carbon brushes
 Disc not included
 Packed by color box



2000W

Ø180mm

INDUSTRIAL

| Unit | PACK /QTY | Qty/Ctn |
|------|-----------|---------|
| PCS | | 2 |

Polisher

| | | |
|----------------|--------------|--|
| AP14008 | 1400W | |
|----------------|--------------|--|

Voltage:220-240V~50/60Hz
 Input power:1400W
 No-load speed:1500-4500rpm
 Polishing pad diameter:180mm
 Variable speed control
 Aluminum gear box
 With 1pcs D-handle
 With 1pcs polishing pad
 With 1pcs polishing bonnet
 With 1set extra carbon brushes
 Packed by color box

1400W Variable speed



| Unit | PACK /QTY | Qty/Ctn |
|------|-----------|---------|
| PCS | | 4 |

Rotary hammer

| | | |
|----------------|-------------|--|
| RGH9528 | 950W | |
|----------------|-------------|--|

Voltage:220-240V~50/60Hz
 Input power:950W
 No-load speed:0-1050rpm
 Impact rate:0-4670bpm
 Impact energy:2.5J
 Max.drilling capacity:
 Concrete:28mm
 Steel:13mm
 Wood:30mm
 SDS plus chuck system
 With 3 drills and 2 chisels
 With 1set extra carbon brushes
 Packed by BMC

950W **28mm**



| Unit | PACK /QTY | Qty/Ctn |
|------|-----------|---------|
| PCS | | 4 |

Demolition breaker

| | | |
|-----------------|--------------|--|
| PDB15006 | 1500W | |
|-----------------|--------------|--|

Voltage:220-240V~50/60Hz
 Input power:1500W
 Impact rate:1000-1900bpm
 Impact force:6-25J
 Anti-vibration system
 Auto-stop carbon brushes
 Constant electronics power
 Chisel-locking system
 SDS-MAX chuck system
 10Kgs demolition breaker
 With 2pcs chisels
 With 1set extra carbon brushes
 Packed by BMC

1500W **10.5kg**

SDS MAX



| Unit | PACK /QTY | Qty/Ctn |
|------|-----------|---------|
| PCS | | 1 |

Demolition breaker

| | | |
|-----------------|--------------|--|
| PDB17008 | 1700W | |
|-----------------|--------------|--|

Voltage:220-240V~50/60Hz
 Input power:1700W
 Impact rate:1400bpm
 Impact force:45J
 HEX chuck system
 16Kgs demolition breaker
 With 2pcs chisels
 With 1set extra carbon brushes
 Packed by BMC

1700W **16kg**

SDS HEX



| Unit | PACK /QTY | Qty/Ctn |
|------|-----------|---------|
| PCS | | 1 |

Circular saw

| | | |
|----------------|--------------|--|
| CS18528 | 1400W | |
|----------------|--------------|--|

Voltage:220-240V~50/60Hz
 Input power:1400W
 No-load speed:4800rpm
 Blade diameter:185x20mm
 Cutting capacity:
 45 degree:45mm
 90 degree:65mm
 Adjustable cutting depth
 Adjustable bevel cutting
 With 1pcs 185mm blade
 With 1set extra carbon brushes
 Packed by color box

1400W



| Unit | PACK /QTY | Qty/Ctn |
|------|-----------|---------|
| PCS | | 2 |

Circular saw

| | | |
|---------------|--------------|--|
| CS2358 | 2200W | |
|---------------|--------------|--|

Voltage:220-240V~50/60Hz
 Input power:2200W
 No-load speed:3800rpm
 Blade diameter: 235x25.4mm
 Cutting capacity:
 45 degree:65mm
 90 degree:80mm
 Aluminum housing
 Adjustable cutting depth
 Adjustable bevel cutting
 With 1pcs 235mm blade
 With 1set extra carbon brushes
 Packed by color box

2200W



| Unit | PACK /QTY | Qty/Ctn |
|------|-----------|---------|
| PCS | | 2 |

Jig saw

| | | |
|----------------|-------------|--|
| JS80028 | 800W | |
|----------------|-------------|--|

Voltage:220-240V~50/60Hz
 Input power:800W
 No-load speed:800-3000rpm
 Cutting capacity:
 Wood:100mm
 Steel:10mm
 Variable speed control
 4 step pendulum function
 Aluminum base
 With 5pcs saw blades
 With 1set extra carbon brushes
 Packed by color box

800W

5PCS

Tool-less blade change system

JIG SAW BLADES FREE



| Unit | PACK /QTY | Qty/Ctn |
|------|-----------|---------|
| PCS | | 5 |

Electric router

| | | |
|-----------------|--------------|--|
| RT160028 | 1600W | |
|-----------------|--------------|--|

Voltage:220-240V~50/60Hz
 Input power:1600W
 No-load speed:22000rpm
 Collet size:6mm,8mm,12mm,1/4",1/2"
 Plunge capacity:0-60mm
 With 1pcs guide holder
 With 1pcs template guide
 With 1pcs trimmer guide
 With 1pcs straight guide
 With 1set extra carbon brushes
 Packed by color box

1600W



| Unit | PACK /QTY | Qty/Ctn |
|------|-----------|---------|
| PCS | | 2 |

Mini grinder

| | | |
|----------------|-------------|--|
| MG13328 | 130W | |
|----------------|-------------|--|

Voltage:220-240V~50/60Hz
 Input power:130W
 No-load speed:10000-35000rpm
 Collet size:3.2mm/2.3mm
 Variable speed control
 With 1pcs flexible shaft
 With 109pcs accessories
 With 1set extra carbon brushes
 Packed by BMC

130W Variable Speed



109Pcs Accessories:

| Unit | PACK /QTY | Qty/Ctn |
|------|-----------|---------|
| PCS | | 5 |

Die grinder

| | | |
|----------------|-------------|--|
| PDG5501 | 550W | |
|----------------|-------------|--|

Voltage:220-240V~50/60Hz
 Input power:550W
 No-load speed:29000rpm
 Collet size:6mm
 Aluminum gear housing
 With 1set extra carbon brushes
 With 3pcs mounted points
 Packed by color box

550W **Ø6mm**



| Unit | PACK /QTY | Qty/Ctn |
|------|-----------|---------|
| PCS | | 10 |

Reciprocating saw

| | | |
|----------------|--------------|--|
| RS12001 | 1200W | |
|----------------|--------------|--|

Voltage:220-240V~50/60Hz
 Input power: 1200W
 No-load speed:1000~2800rpm
 Max.cutting depth:
 Wood:210mm
 Steel:20mm
 Aluminum:10mm
 Variable speed control
 Integrated work light
 4 step pendulum function
 SDS blade change chuck
 With 1pcs metal saw blade
 With 1pcs wood saw blade
 With 1set extra carbon brushes
 Packed by color box

1200W

| Unit | PACK /QTY | Qty/Ctn |
|------|-----------|---------|
| PCS | | 4 |

Electric planer

| | | |
|---------------|-------------|--|
| PL7508 | 750W | |
|---------------|-------------|--|

Voltage:220-240V~50/60Hz
 Input power:750W
 No-load speed:17000rpm
 Planing width&depth:82x2mm
 Heavy duty aluminum base
 Aluminum side cover
 With 1 pcs socket wrench
 With 1 pcs parallel guide
 With 1 set extra carbon brushes
 Packed by color box

750W

| Unit | PACK /QTY | Qty/Ctn |
|------|-----------|---------|
| PCS | | 4 |

Marble cutter

| | | |
|----------------|--------------|--|
| MC14008 | 1400W | |
|----------------|--------------|--|

Voltage:220-240V~50/60Hz
 Input power:1400W
 No-load speed:13000rpm
 Diameter of blade:110x20mm
 Max.cutting capacity:34mm
 Adjustable cutting depth
 Include 1pcs dry diamond disc
 Packed by color box

1400W

Ø110mm

| Unit | PACK /QTY | Qty/Ctn |
|------|-----------|---------|
| PCS | | 4 |

Heat gun

| | | |
|-----------------|--------------|--|
| HG200028 | 2000W | |
|-----------------|--------------|--|

Voltage:220-240V~50/60Hz
 Input power:2000W
 Temperature:50°C/380°C/570°C
 Airflow:500/300/500 L/min
 With 1pcs scraper and 4pcs nozzles
 Packed by color box

2000W

| Unit | PACK /QTY | Qty/Ctn |
|------|-----------|---------|
| PCS | | 8 |

Aspirator blower

| | | |
|---------------|-------------|--|
| AB4018 | 400W | |
|---------------|-------------|--|

Voltage:220-240V~50/60Hz
 Input power:400W
 No-load speed:14000rpm
 Max.blowing rate:3.0m³/min
 With 1pcs dust bag
 Packed by color box

400W

0-3.0m³/min

| Unit | PACK /QTY | Qty/Ctn |
|------|-----------|---------|
| PCS | | 4 |

Aspirator blower

| | | |
|---------------|-------------|--|
| AB6008 | 600W | |
|---------------|-------------|--|

Voltage:220-240V~50/60Hz
 Input power:600W
 No-load speed:0-16000rpm
 Blowing rate:0-3.5m³/min
 Variable speed control
 With 1pcs dust bag
 Packed by color box

600W

0-3.5m³/min

| Unit | PACK /QTY | Qty/Ctn |
|------|-----------|---------|
| PCS | | 4 |



Cut off saw

| | |
|-----------------|--------------|
| COS35568 | 2400W |
|-----------------|--------------|

Voltage:220-240V~50/60Hz
 Input power:2400W
 No-load speed:3900rpm
 Blade size:355mmx25.4mmx3mm
 Max. cutting capacity:
 100mm in round pipe
 100mmx100mm in square steel
 120mmx100mm in rectangle
 Max. cutting steel bar:50mm
 With 1pcs 355mm cutting disc
 Packed by color box

2400W Ø355mm



| Unit | PACK /QTY | Qty/Ctn |
|------|-----------|---------|
| PCS | | 1 |

Mitre saw

| | |
|-----------------|--------------|
| BMS14002 | 1400W |
|-----------------|--------------|

Voltage:220-240V~50/60Hz
 Input power:1400W
 No-load speed:5000rpm
 Blade size:210mmx25.4mm
 Max. cutting capacity:55mmx120mm
 Mitre cuts 0-45° left and right
 Bevel cuts up to 45° to the left
 With 1set extra carbon brushes
 With 1pcs TCT blade
 With 1pcs dust bag
 Packed by color box

1400W Ø210mm



| Unit | PACK /QTY | Qty/Ctn |
|------|-----------|---------|
| PCS | | 1 |

Automatic pump control

| | |
|----------------|---------------|
| WAPS002 | 1.5bar |
|----------------|---------------|

Rated voltage:220-240V
 Frequency:50/60Hz
 Starting pressure:1.5bar
 Max. current:10A
 Max. pressure:10bar
 Pipe diameter:1"x1"
 Protection degree:IP65
 Packed by color box

10Bar 10A



| Unit | PACK /QTY | Qty/Ctn |
|------|-----------|---------|
| PCS | | 12 |

Inverter MMA welding machine

| | |
|--------------------|-------------|
| ING-MMA2006 | 200A |
|--------------------|-------------|

IGBT inverter technology
 Input voltage(V):1-220-240
 Frequency(Hz):50/60
 Output current(A):10-200
 Duty cycle(%):200A@60%
 LCD display
 No-load voltage(V):70
 Max. output current(A):200
 Diameter of electrode(mm):1.6-5.0
 Anti-stick/Hot start/Arc-force
 With 1pcs electrode holder with cable
 With 1pcs earth clamp with cable
 With 1pcs wire brush and 1pcs helmet
 Packed by carton box

IGBT 200A MMA



| Unit | PACK /QTY | Qty/Ctn |
|------|-----------|---------|
| PCS | | 2 |

7 Pcs magnetic welding holder set

| | |
|-----------------|-------------|
| AMWH7002 | 7Pcs |
|-----------------|-------------|

7pcs Magnetic Welding Holder Set
 Specifications:
 2pcs Mini Magnet
 2pcs 3" Magnet
 2pcs 3" Multi-angle Magnet
 1pcs 4" Magnet
 Pull Force:
 Mini 10Lbs
 3" 25Lbs
 3" Multi-angle 25Lbs
 4" 50Lbs
 Product Dimensions per pcs:
 Mini 70*42.5*12mm
 3" 120*83*14.4mm

7PCS/SET
10LBS
25LBS
50LBS



| Unit | PACK /QTY | Qty/Ctn |
|------|-----------|---------|
| SET | 5 | 10 |

Electrode holder

| | |
|----------------|-------------|
| WAH3008 | 300A |
|----------------|-------------|

Unique design new design
 Rated current:300A
 Suitable for MMA welding machine
 Packed by carton box

300A

New design
Unique design



Copper

| Unit | PACK /QTY | Qty/Ctn |
|------|-----------|---------|
| PCS | | 40 |

Electrode holder

| | |
|----------------|-------------|
| WAH5008 | 500A |
|----------------|-------------|

Unique design new design
 Rated current:500A
 Netherlands type
 Suitable for MMA welding machine(Below 500A)
 Packed by carton box

500A

New design
Unique design



Copper

| Unit | PACK /QTY | Qty/Ctn |
|------|-----------|---------|
| PCS | | 30 |

Auto air compressor

| | |
|----------------|--------------------|
| AAC2508 | 120PSI/8BAR |
|----------------|--------------------|

Voltage:12V
 Current:18A
 Max pressure:120PSI/8BAR
 Integrated work light
 With 1pcs battery clips
 With 4pcs adapters
 With 1pcs 5m air hose with a brass quick-releasing adapter
 With 1pcs canvas bag
 Packed by color box

120PSI



| Unit | PACK /QTY | Qty/Ctn |
|------|-----------|---------|
| PCS | | 4 |

Booster cable with lamp

| | |
|-------------------|-------------|
| HBTCP6008L | 600A |
|-------------------|-------------|

Current: 600AMP
 With LED lamp
 Clamp size :18x11cm
 Suitable for emission ≤4.5L car
 Cable material :copper coated aluminum
 Cable outside diameter:10mm
 Cable length :3m
 Packed by color box

600A

LED LAMP



≤4.5L
L:3m
D:10mm

| Unit | PACK /QTY | Qty/Ctn |
|------|-----------|---------|
| SET | | 8 |

Air spray gun

| | |
|----------------|---------------|
| ASG3101 | 1000cc |
|----------------|---------------|

Standard nozzle:1.5mm
 Pattern width:140-180mm
 Paint capacity:1000cc
 Suitable for base coat
 With Europe type connector, USA type connector, Nitto type connector and Italy type connector.
 Optional nozzle:1.2-1.8mm
 Operating pressure:3-4bar
 Air cons:4.2-7.1cfm(119-200l/min)
 Packed by color box

1000cc Base Coat

1.5mm



| Unit | PACK /QTY | Qty/Ctn |
|------|-----------|---------|
| PCS | | 10 |

Air impact wrench

AIW12562 **12.5mm/1/2"**

Square drive:12.5mm(1/2")
 No-load speed:7000/min
 Max.torque:610Nm(450Ft-lb)
 Weight: 2.6KG
 Twin hammer mechanism
 With 3 pcs socket (17mm,19mm,21mm)
 With Europe type connector, USA type connector,
 Nitto type connector and Italy type connector.
 Air Consumption:142.5l/min(5.0cfm)
 Air Pressure:6.3bar(90psi)
 Length:187mm(7.3")
 Weight:2.6kgs(5.7lbs)
 Air Inlet:1/4"
 Air hose:3/8"
 Packed by color box



| Unit | PACK /QTY | Qty/Ctn |
|------|-----------|---------|
| PCS | | 6 |

10 Pcs 1/2"DR. impact socket set

HKISSD12101 **CrMo**

10 Pcs 1/2"DR. impact socket set
 Material:CrMo
 Size:10,12,13,14,15,17,19,21,22,24mm
 Heat treatment
 Packed by plastic hanger



| Unit | PACK /QTY | Qty/Ctn |
|------|-----------|---------|
| SET | 6 | 12 |

10 Pcs 1/2" deep impact socket set

HKISSD12102L **CrMo**

10 Pcs 1/2"DR. deep impact socket set
 Size:10,12,13,14,15,17,19,21,22,24mm
 length:78mm
 Material:CrMo
 Heat treatment
 Packed by plastic hanger



| Unit | PACK /QTY | Qty/Ctn |
|------|-----------|---------|
| SET | 5 | 10 |

Air impact wrench

AIW341302 **19mm/3/4"**

Square drive:19mm(3/4")
 No-load speed:4000 rpm
 Max.torque:1600Nm(1180ft)
 Twin hammer mechanism
 With universal connector.
 Air Consumption:256l/min(9cfm)
 Air Pressure:6.3bar(90psi)
 Length:234mm(9.2")
 Weight:5.9kgs(13lbs)
 Air Inlet:3/8"
 Air hose:1/2"
 Packed by color box



| Unit | PACK /QTY | Qty/Ctn |
|------|-----------|---------|
| PCS | | 4 |

Air impact wrench

AIW11222 **25mm/1"**

Square drive:25.4mm(1")
 No-load speed:3600/min
 Max.torque:3100Nm(2220Ft-lb)
 Weight: 18.5KG
 With universal connector.
 Air Consumption:36Cfm(1019l/min)
 Anvil:200mm(8")
 Capacity bolt Size:45mm(1-3/4")
 Air inlet:1/2"
 Air hose:5/8"
 Packed by BMC



| Unit | PACK /QTY | Qty/Ctn |
|------|-----------|---------|
| PCS | | 1 |



Hedge shear

HHS6301 **557mm/22"**

Length:22"(557mm)
 Material:55# carbon steel
 Heat treatment blade
 Blade painted teflon
 Packed by paper hanger



| Unit | PACK /QTY | Qty/Ctn |
|------|-----------|---------|
| PCS | 6 | 12 |

Lopper

HLT7401 **760mm/30"**

Length:30"(760mm)
 Max cutting diameter:25mm
 Material:55# carbon steel
 Stress function on blade
 Heat treatment blade
 Blade painted teflon
 Packed by paper hanger



| Unit | PACK /QTY | Qty/Ctn |
|------|-----------|---------|
| PCS | 6 | 12 |

High pressure washer

HPWR14008 **1400W**

Voltage: 220-240V~50/60Hz
 Carbon brush motor
 Pure copper wire
 Input power:1400W
 Max Pressure:130Bar (1900PSI)
 Flow rate:5.5L/min
 Auto stop system
 1 set water spray gun (AMSG028)
 5m high pressure hose(AHPH5028)
 Packed by color box



| Unit | PACK /QTY | Qty/Ctn |
|------|-----------|---------|
| PCS | | 1 |

High pressure washer

HPWR18008 **1800W**

Voltage: 220-240V~50/60Hz
 Carbon brush motor
 Pure copper wire
 Input power:1800W
 Max Pressure:150Bar (2200PSI)
 Flow rate:6.0L/min
 Auto stop system
 1pcs soap bottle
 1 set water spray gun (AMSG028)
 5m high pressure hose(AHPH5028)
 Packed by color box



| Unit | PACK /QTY | Qty/Ctn |
|------|-----------|---------|
| PCS | | 1 |

6 Pcs HSS twist drill bits set

AKDB1065 **6Pcs**

Size: 2X49,3X61, 4X75, 5X86,6X93, 8X117
6pcs HSS twist drill bits set
Packed by double blister



| Unit | PACK /QTY | Qty/Ctn |
|------|-----------|---------|
| SET | 40 | 80 |

12 Pcs HSS twist drill bits set

AKDB1125 **12Pcs**

12pcs HSS twist drill bits set
Size: 2,2.5,3,3.5,4,4.5,5,5.5,6,6.5,7,8mm
Packed by double blister



| Unit | PACK /QTY | Qty/Ctn |
|------|-----------|---------|
| SET | 20 | 40 |

5 Pcs masonry drill bits set

AKDB3055 **5Pcs**

Size: 4X75, 5X85, 6X100, 8X120, 10X120
5PCS Masonry drill bits set
Packed by double blister



| Unit | PACK /QTY | Qty/Ctn |
|------|-----------|---------|
| SET | 40 | 80 |

19 Pcs HSS twist drill bits set

AKDB1195 **19Pcs**

19pcs HSS twist drill bits set
Size:
1,1.5,2,2.5,3,3.5,4,4.5,5,5.5,6,6.5,7,7.5,8,8.5,9,9.5,10mm
Packed by plastic box



| Unit | PACK /QTY | Qty/Ctn |
|------|-----------|---------|
| SET | 10 | 40 |

25Pcs HSS drill bits set

AKD1251 **25Pcs**

25PCS HSS drill bits
Size:1.0,1.5,2.0,2.5,3.0,3.5,4.0,4.5,5.0,5.5,6.0,6.5,7.0,7.5,8.0,8.5,9.0,9.5,10.0,10.5,11,11.5,12,12.5,13MM.
Fully ground flute,135°
High quality M2 high speed steel
Drill bit size:1-13mm/0.5mm
Packed by plastic box



| Unit | PACK /QTY | Qty/Ctn |
|------|-----------|---------|
| SET | | 10 |

120 Pcs accessories set

HKTAC011201 **120Pcs**

120 Pcs accessories set
Include:

- 6pcs masonry drill bits:3mm,4mm,5mm,6mm,8mm,10mm
- 19pcs HSS twist drill bits: 1mm,1.5mm,2mm,2.5mm,3mm,3.5mm,4mm,4.5mm,5mm,5.5mm,6mm,6.5mm, 7mm, 7.5mm, 8mm,8.5mm,9mm,9.5mm,10mm
- 6pcs wood twist drill bits:3mm,4mm,5mm,6mm,8mm,10mm
- 52pcs 25mm length screwdriver bits:



| Unit | PACK /QTY | Qty/Ctn |
|------|-----------|---------|
| SET | | 5 |

SDS plus chisel

DBC0112501 **14x250mm**

14X250mm,pointed
Packed by plastic hanger



| Unit | PACK /QTY | Qty/Ctn |
|------|-----------|---------|
| PCS | | 50 |

SDS plus chisel

DBC0122501 **14x250x20mm**

14X250 X 20mm,flat
Packed by plastic hanger



| Unit | PACK /QTY | Qty/Ctn |
|------|-----------|---------|
| PCS | | 50 |

SDS plus chisel

DBC0122502 **14x250x40mm**

14X250 X 40mm,flat
Packed by plastic hanger



| Unit | PACK /QTY | Qty/Ctn |
|------|-----------|---------|
| PCS | | 50 |

Abrasive metal cutting disc

MCD121151 **115x1.2x22.2m**

115mm(4/ 1/2")X1.2mm(3/64")X22.2mm(7/8")
Flat centre
Cutting disc for metal and INOX
Packed by label



| Unit | PACK /QTY | Qty/Ctn |
|------|-----------|---------|
| PCS | 100 | 400 |

Abrasive metal cutting disc

MCD301151 115x3.0x22.2mm

115mm(4-1/2")X3.0mm(1/8")X22.2mm(7/8")
Depressed centre
Cutting disc for metal
Packed by label



115x3.0mm Depressed

| Unit | PACK /QTY | Qty/Ctn |
|------|-----------|---------|
| PCS | 50 | 200 |

Abrasive metal cutting disc

MCD303551 355x3.0x25.4mm

355mm(14")X3.0mm(1/8")X25.4mm(1")
Flat centre
Cutting disc for metal
Packed by label



355x3.0mm Flat
Double fibre

| Unit | PACK /QTY | Qty/Ctn |
|------|-----------|---------|
| PCS | | 25 |

Abrasive metal grinding disc

MGD601151 115x6.0x22.2mm

115mm(4-1/2")X6.0mm(1/4")X22.2mm(7/8")
Depressed centre
Grinding disc for metal
Packed by label



115x6.0mm Depressed

| Unit | PACK /QTY | Qty/Ctn |
|------|-----------|---------|
| PCS | 25 | 100 |

Diamond disc set

DMD011152M 115x22.2mm

115(4-1/2")X22.2mm
Blade width:7.5mm
10pcs/metal box
Unit price is for 1 piece
Packed by metal box

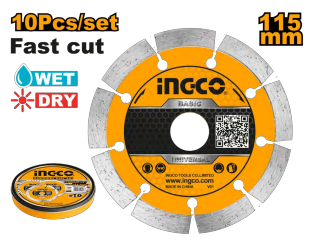

10Pcs/set Fast cut
WET DRY
115mm

| Unit | PACK /QTY | Qty/Ctn |
|------|-----------|---------|
| PCS | 10 | 100 |

Dry diamond disc

DMD0111523 115x22mm

115(4-1/2")X22.2mm
Blade width:7mm
2pcs/set
Packed by color box



2Pcs/set Fast cut
WET DRY
115mm
SUPER SELECT

| Unit | PACK /QTY | Qty/Ctn |
|------|-----------|---------|
| SET | 25 | 50 |

Diamond cup wheels

CGW011151 115x22.22mm

Diameter:115mm
Blade width:20mm
Arbor:22.22mm
Packed by color box



115mm(4-1/2")
WET

| Unit | PACK /QTY | Qty/Ctn |
|------|-----------|---------|
| PCS | | 20 |

Diamond cup wheels

CGW021151 115x22.22mm

Diameter:115mm
18pcs blades
Arbor:22.22mm
Packed by color box



115mm(4-1/2")
WET

| Unit | PACK /QTY | Qty/Ctn |
|------|-----------|---------|
| PCS | | 20 |

TCT saw blade

TSB111555 115x22.2mm

115mm(4-1/2"),
40T,arbor:22.2mm
Reduction ring:16mm
wood Cutting
Packed by color box



115mm(4-1/2")
Wood
40T
INDUSTRIAL

| Unit | PACK /QTY | Qty/Ctn |
|------|-----------|---------|
| PCS | 25 | 100 |

TCT saw blade

TSB118513 185x20mm

185mm(7-1/4")
60T,arbor:20mm
With 16mm reduction ring
Suitable for circular sawFor item CS18528
Wood cutting
Packed by color box



185mm(7-1/4")
Wood
60T
INDUSTRIAL

| Unit | PACK /QTY | Qty/Ctn |
|------|-----------|---------|
| PCS | 25 | 50 |

TCT saw blade

TSB121022 210x30mm

210mm(8-1/4")
48T,arbor:30mm
16mm and 25.4mm ring
Suitable for mitre sawFor item BMS14002
Wood cutting
Packed by color box



210mm(8-1/4")
Wood
48T
INDUSTRIAL

| Unit | PACK /QTY | Qty/Ctn |
|------|-----------|---------|
| PCS | 25 | 50 |

TCT saw blade

TSB123525 **235x30mm**

235mm(9-1/4")
40T, arbor:30mm
16mm and 25.4 ring
Suitable for circular saw item CS2358
Wood cutting
Packed by color box

40T

| Unit | PACK /QTY | Qty/Ctn |
|------|-----------|---------|
| PCS | 5 | 25 |

TCT saw blade

TSB125423 **254x30mm**

254mm(10")
60T, arbor:30mm
16mm and 25.4mm ring
Suitable for mitre saw
For item BM2S18004
Wood cutting
Packed by color box

60T

| Unit | PACK /QTY | Qty/Ctn |
|------|-----------|---------|
| PCS | 5 | 25 |

TCT saw blade for aluminum

TSB3254210 **254x30mm**

254mm(10")
100T, arbor:30mm
16mm and 25.4mm ring
Suitable for mitre saw
For item BM2S18004
Aluminum cutting
Packed by color box

100T

| Unit | PACK /QTY | Qty/Ctn |
|------|-----------|---------|
| PCS | 5 | 25 |

Wire cup brush

WB10751 **75mm/3"**

Dia: 75mm, 3"
Thread: M14x2
Wire dia: 0.3mm
Wire length: 23mm
RPM: 12500r/min
Apply on: planing, deburring, edge honing, descaling/paint stripping, weld seams
Suitable for: Steel, Cast steel, Soft wood, Hard wood
Packed by double blister

75mm(3")

| Unit | PACK /QTY | Qty/Ctn |
|------|-----------|---------|
| PCS | 10 | 80 |

Wire cup brush

WB11001 **100mm/4"**

Dia: 100mm, 4"
Thread: M14x2
Wire dia: 0.3mm
Wire length: 30mm
RPM: 8500r/min
Apply on: planing, deburring, edge honing, descaling/paint stripping, weld seams
Suitable for: Steel, Cast steel, Soft wood, Hard wood
Packed by double blister

100mm(4")

| Unit | PACK /QTY | Qty/Ctn |
|------|-----------|---------|
| PCS | 10 | 60 |

Wire cup brush

WB20751 **75mm/3"**

Dia: 75mm, 3"
Thread: M14x2
Wire dia: 0.5mm
Wire length: 23mm
RPM: 12500r/min
Apply on: roughening, descaling/paint stripping, weld seams
Suitable for: Steel, Cast steel
Packed by double blister

75mm(3")

| Unit | PACK /QTY | Qty/Ctn |
|------|-----------|---------|
| PCS | 10 | 80 |

Wire cup brush

WB30501 **50mm/2"**

Dia: 50mm, 2"
Shank dia: 1/4"
Wire dia: 0.3mm
Wire length: 17mm
RPM: 4500r/min
Apply on: planing, deburring, edge honing, descaling/paint stripping, weld seams
Suitable for: Steel, Cast steel, Soft wood, Hard wood
Packed by double blister

50mm(2")

| Unit | PACK /QTY | Qty/Ctn |
|------|-----------|---------|
| PCS | 12 | 144 |

Wire wheels

WB40501 **50mm/2"**

Dia: 50mm, 2"
Shank dia: 1/4"
Wire dia: 0.3mm
Wire length: 10mm
RPM: 4500r/min
Apply on: planing, deburring, edge honing, descaling/paint stripping, weld seams
Suitable for: Steel, Cast steel, Soft wood, Hard wood
Packed by double blister

50mm(2")

| Unit | PACK /QTY | Qty/Ctn |
|------|-----------|---------|
| PCS | 20 | 240 |

Wire wheels

WB40751 **75mm/3"**

Dia: 75mm, 3"
Shank dia: 1/4"
Wire dia: 0.3mm
Wire length: 16mm
RPM: 4500r/min
Apply on: planing, deburring, edge honing, descaling/paint stripping, weld seams
Suitable for: Steel, Cast steel, Soft wood, Hard wood
Packed by double blister

75mm(3")

| Unit | PACK /QTY | Qty/Ctn |
|------|-----------|---------|
| PCS | 12 | 144 |

Wool polishing bonnet

APB0111801 **180mm**

Diameter:180mm
Real wool bonnet
Packed by color box

180mm(7")

| Unit | PACK /QTY | Qty/Ctn |
|------|-----------|---------|
| PCS | 20 | 80 |

Screwdriver bits

SDB21HL133 S2

PH2+SL6,0.65mm,10pcs/set
S2 industrial steel
double end bit
Nickle plated magnetic
Packed by plastic box

65mm
10PCS/SET



Unit: SET, PACK /QTY: 25, Qty/Ctn: 100

Screwdriver bits

SDB21PH233 S2

PH2, Double end bits, NICKLE PLATED
MEGNETIC 65mm,10pcs/set
S2 industrial steel
Packed by plastic box

65mm
10PCS/SET



Unit: SET, PACK /QTY: 25, Qty/Ctn: 100

6 Pcs magnetic nut set

AMN65061 6Pcs/set

6pcs/set
6mm,7mm,8mm,9mm,10mm,12mm
Shank:1/4" Hex
Length:65mm
Material:50BV30
With strong magnet
Packed by plastic box

1/4"
6PCS/SET

6mm,7mm,8mm,9mm,10mm,12mm



Unit: SET, PACK /QTY: 10, Qty/Ctn: 50

8 Pcs jig saw blades set

AKD8088 8Pcs

1PCS 127D for cutting aluminum
1PCS JBT101D for cutting wood (clean surface)
2PCS JBT118B for cutting metal
4PCS JBT111C for cutting wood(fast cut)
8pcs Jig saw blades set
Packed by plastic box

8PCS/SET



Unit: PCS, PACK /QTY: 24, Qty/Ctn: 24

Sabre saw blade

SSB644D 150x19x1.25mm

Top for Wood
150mmX19mmX1.25mm
6TPI - HCS - Milled
Suitable for RS8008
1/2" shank,2pcs/set
Fast cutting for wood, composition materials and plastic(dia.<100mm)
Packed by blister card

2PCS/SET
150x19x1.25mm



Unit: SET, PACK /QTY: 25, Qty/Ctn: 100

Sabre saw blade

SSB922EF 150x19x0.9mm

Flexible for Metal
150mmX19mmX0.9mm
18TPI - Bi-Metal - Milled
Suitable for RS8008
1/2" shank,2pcs/set
Cuts all metals including nonferrous pipe (<100mm) conduit, stainless and sheet metals(1.5-4mm)
Packed by blister card

2PCS/SET
150x19x0.9mm



Unit: SET, PACK /QTY: 25, Qty/Ctn: 100

Bi-metal hole saw set

AKH0121 12Pcs

Hole saw 12pcs set
Size:20mm(25/32"),22mm(7/8"),25mm(1"),29mm(1-1/8"),32mm(1-1/4"),35mm(1-3/8"),38mm(1-1/2"),44mm(1-3/4"),48mm(1-7/8"),50mm(1-31/32")
1 pcs arbor: 1/4" Round Shank, Fit Size: 9/16"-1-3/16"
1 pcs arbor: 7/16" Hex Shank, Fit Size: 1-1/4"-8-17/64"
Packed by Aluminum case

BIM
12PCS/SET



Unit: SET, PACK /QTY: 10, Qty/Ctn: 10

Flap disc

FD1151 P40

Size: 115mm*22mm,P40
Suitable for high steel, steel, cast iron and sheet steel
Packed by label

P40
115mm(4-1/2")



Unit: PCS, PACK /QTY: 60, Qty/Ctn: 60

Flap disc

FD1152 P60

Size: 115mm*22mm,P60
Suitable for high steel, steel, cast iron and sheet steel
Packed by label

P60
115mm(4-1/2")



Unit: PCS, PACK /QTY: 60, Qty/Ctn: 60

Mix paddle

MP1120 120mm

Diameter:120mm
Length:600mm
Tool fitting:M14x2
Mixing from top down
Packed by paper card

120mm



Unit: PCS, PACK /QTY: 2, Qty/Ctn: 10

Flap disc

FD1153 P80

Size: 115mm*22mm,P80
Suitable for high steel, steel, cast iron and sheet steel
Packed by label

P80
115mm(4-1/2")



Unit: PCS, PACK /QTY: 60, Qty/Ctn: 60

Machinist hammer

HMH880500 **500g**

Weight: 500g
Drop-forged hammerhead
Heat treatment,45# carbon steel
Unique design fiberglass handle
Packed by label

Fiberglass handle 500g



 Drop forged **SUPER SELECT**

| Unit | PACK /QTY | Qty/Ctn |
|------|-----------|---------|
| PCS | 6 | 24 |

Machinist hammer

HMH881000 **1000g**

Weight: 1000g
Drop-forged hammerhead
Heat treatment,45# carbon steel
Unique design fiberglass handle
Packed by label

Fiberglass handle 1000g



 Drop forged **SUPER SELECT**

| Unit | PACK /QTY | Qty/Ctn |
|------|-----------|---------|
| PCS | 6 | 12 |

Machinist hammer

HMH881500 **1500g**

Weight: 1500g
Drop-forged hammerhead
Heat treatment,45# carbon steel
Unique design fiberglass handle
Packed by label

Fiberglass handle 1500g



 Drop forged **SUPER SELECT**

| Unit | PACK /QTY | Qty/Ctn |
|------|-----------|---------|
| PCS | 4 | 12 |

Machinist hammer

HMH882000 **2000g**

Weight: 2000g
Drop-forged hammerhead
Heat treatment,45# carbon steel
Unique design fiberglass handle
Packed by label

Fiberglass handle 2000g



 Drop forged **SUPER SELECT**

| Unit | PACK /QTY | Qty/Ctn |
|------|-----------|---------|
| PCS | 6 | 12 |

Stoning hammer

HSTHS81000 **1000g**

Weight: 1000g
Drop-forged hammerhead
Heat treatment,45# carbon steel
Unique design fiberglass handle
Packed by label

Fiberglass handle 1000g



 Drop forged **SUPER SELECT**

| Unit | PACK /QTY | Qty/Ctn |
|------|-----------|---------|
| PCS | 6 | 12 |

Stoning hammer

HSTH8803 **1500g**

Weight: 1500g
Drop-forged hammerhead
Heat treatment,45# carbon steel
Unique design fiberglass handle
Packed by label

Fiberglass handle 1500g



 Drop forged **SUPER SELECT**

| Unit | PACK /QTY | Qty/Ctn |
|------|-----------|---------|
| PCS | 4 | 12 |

Stoning hammer

HSTH8804 **2000g**

Weight: 2000g
Drop-forged hammerhead
Heat treatment,45# carbon steel
Unique design fiberglass handle
Packed by label

Fiberglass handle 2000g



 Drop forged **SUPER SELECT**

| Unit | PACK /QTY | Qty/Ctn |
|------|-----------|---------|
| PCS | 4 | 8 |

Sledge hammer

HSLH8802 **2LB**

Weight: 2LB
Drop-forged hammerhead
Heat treatment,45# carbon steel
Unique design fiberglass handle
Packed by label

Fiberglass handle 2LB



 Drop forged **SUPER SELECT**

| Unit | PACK /QTY | Qty/Ctn |
|------|-----------|---------|
| PCS | 6 | 12 |

Sledge hammer

HSLH8803 **3LB**

Weight: 3LB
Drop-forged hammerhead
Heat treatment,45# carbon steel
Unique design fiberglass handle
Packed by label

Fiberglass handle 3LB



 Drop forged **SUPER SELECT**

| Unit | PACK /QTY | Qty/Ctn |
|------|-----------|---------|
| PCS | 4 | 12 |

Sledge hammer

HSLH8804 **4LB**

Weight: 4LB
Drop-forged hammerhead
Heat treatment,45# carbon steel
Unique design fiberglass handle
Packed by label

Fiberglass handle 4LB



 Drop forged **SUPER SELECT**

| Unit | PACK /QTY | Qty/Ctn |
|------|-----------|---------|
| PCS | 4 | 8 |

British type claw hammer

HCH880227 **27mm**

SIZE: 27mm
Drop-forged hammerhead
Heat treatment, 45# carbon steel
Unique design fiberglass handle
Packed by label

Fiberglass handle 27mm
British type



Drop forged **SUPER SELECT**

| Unit | PACK /QTY | Qty/Ctn |
|------|-----------|---------|
| PCS | 6 | 18 |

Ball pein hammer

HBPHS8016 **450g/16oz**

Weight: 16oz/450g
Drop-forged hammerhead
Heat treatment, 45# carbon steel
Unique design fiberglass handle
Packed by label

Fiberglass handle 16oz



Drop forged **SUPER SELECT**

| Unit | PACK /QTY | Qty/Ctn |
|------|-----------|---------|
| PCS | 6 | 18 |

Ball pein hammer

HBPH88024 **660g/24oz**

Weight: 24oz/660g
Drop-forged hammerhead
Heat treatment, 45# carbon steel
Unique design fiberglass handle
Packed by label

Fiberglass handle 24oz



Drop forged **SUPER SELECT**

| Unit | PACK /QTY | Qty/Ctn |
|------|-----------|---------|
| PCS | 6 | 18 |

Claw hammer

HCH8816 **450g/16oz**

Weight: 16oz/450g
Unique design handle
All steel drop-forged claw hammer
Heat treatment
Packed by paper card

Anti-shock handle 16oz



Overall forged

| Unit | PACK /QTY | Qty/Ctn |
|------|-----------|---------|
| PCS | 6 | 12 |

Claw hammer

HCH0820 **560g/20oz**

Weight: 20oz/560g
Unique design handle
All steel drop-forged claw hammer
Heat treatment
Packed by paper card

Anti-shock handle 20oz



Overall forged

| Unit | PACK /QTY | Qty/Ctn |
|------|-----------|---------|
| PCS | 6 | 12 |

Rubber and plastic hammer

HRPH8140 **40mm**

Hammer diameter: 40mm
Soft face
Protect workpiece surface
Unique design fiberglass handle
Packed by label

Fiberglass handle 40mm



| Unit | PACK /QTY | Qty/Ctn |
|------|-----------|---------|
| PCS | 10 | 30 |

Dead blow mallet

HDBM01028 **2LB**

Dead blow mallet
Weight: 2LB
Non-marring plastic faces
Non-rebounding
Non-spark
Unique design fiberglass handle
Packed by label

Fiberglass handle 2LB



| Unit | PACK /QTY | Qty/Ctn |
|------|-----------|---------|
| PCS | 6 | 24 |

Axe

HAX0208008 **800g**

Weight: 800g
Drop-forged axe head
Heat treatment, 45# carbon steel
Unique design fiberglass handle
Packed by label

Fiberglass handle 800g



| Unit | PACK /QTY | Qty/Ctn |
|------|-----------|---------|
| PCS | 6 | 12 |

Combination pliers

HCP28208 **8"/200mm**

Size: 8"/200mm
Cr-V, black finish and polish
TPR two color handle
Packed by PP hanger

Cr-V 200mm(8")



| Unit | PACK /QTY | Qty/Ctn |
|------|-----------|---------|
| PCS | 6 | 36 |

Diagonal cutting pliers

HDPC28188 **7"/180mm**

Size: 7"/180mm
Cr-V, black finish and polish
TPR two color handle
Packed by PP hanger

Cr-V 180mm(7")



| Unit | PACK /QTY | Qty/Ctn |
|------|-----------|---------|
| PCS | 6 | 36 |

Heavy-duty diagonal cutting pliers

HHDCP28188 7"/180mm

INDUSTRIAL

CrV 180mm(7")

Size: 7"/180mm
Cr-V,black finish and polish
TPR two color handle
Packed by PP hanger



| Unit | PACK /QTY | Qty/Ctn |
|------|-----------|---------|
| PCS | 6 | 36 |

Long nose pliers

HLNP28168 6"/160mm

INDUSTRIAL

CrV 160mm(6")

Size: 6"/160mm
Cr-V,black finish and polish
TPR two color handle
Packed by PP hanger



| Unit | PACK /QTY | Qty/Ctn |
|------|-----------|---------|
| PCS | 6 | 36 |

Long nose pliers

HLNP28208 8"/200mm

INDUSTRIAL

CrV 200mm(8")

Size: 8"/200mm
Cr-V,black finish and polish
TPR two color handle
Packed by PP hanger



| Unit | PACK /QTY | Qty/Ctn |
|------|-----------|---------|
| PCS | 6 | 36 |

End cutting pliers

HECP28160 6"/160mm

INDUSTRIAL

CrV 160mm(6")

Size: 6"/160mm
Cr-V,black finish and polish
TPR two color handle
Packed by PP hanger



| Unit | PACK /QTY | Qty/Ctn |
|------|-----------|---------|
| PCS | 6 | 36 |

High leverage combination pliers

HHCP28180 7"/180mm

INDUSTRIAL

CrV 180mm(7")

Size: 7"/180mm
Cr-V,black finish and polish
TPR two color handle
Saving 30% strength than normal pliers
Packed by PP hanger



30% Save 30% Strength

| Unit | PACK /QTY | Qty/Ctn |
|------|-----------|---------|
| PCS | 6 | 36 |

High leverage combination pliers

HHCP28240 9.5"/240mm

INDUSTRIAL

CrV 240mm(9.5")

Size: 9.5"/240mm
Cr-V,black finish and polish
TPR two color handle
Saving 30% strength than normal pliers
Packed by PP hanger



30% Save 30% Strength

| Unit | PACK /QTY | Qty/Ctn |
|------|-----------|---------|
| PCS | 6 | 36 |

3 Pcs pliers set

HKPS28318 3Pcs

INDUSTRIAL

CrV 3PCS/SET

Size:
8" Combination pliers
6" Long nose pliers
6" Diagonal cutting pliers
Cr-V,black finish and polish
TPR two color handle
Packed by PP hanger



| Unit | PACK /QTY | Qty/Ctn |
|------|-----------|---------|
| SET | 5 | 20 |

Rabbit pliers

HRP02200 8"/200mm

INDUSTRIAL

CrV 200mm(8")

Size: 8"/200mm
Cr-V,black finish and polish
With plastic handle
Packed by PP hanger



| Unit | PACK /QTY | Qty/Ctn |
|------|-----------|---------|
| PCS | 6 | 36 |

Rabbit pliers

HRP02250 10"/250mm

INDUSTRIAL

CrV 250mm(10")

Size: 10"/250mm
Cr-V,black finish and polish
With plastic handle
Packed by PP hanger



| Unit | PACK /QTY | Qty/Ctn |
|------|-----------|---------|
| PCS | 6 | 36 |

Slip joint pliers

HSPJP02200 8"/200mm

INDUSTRIAL

200mm(8")

Size: 8"/200mm
Black finish and polish
Packed by PP hanger

Black finish and Polish



| Unit | PACK /QTY | Qty/Ctn |
|------|-----------|---------|
| PCS | 6 | 36 |

Slip joint pliers

| | | |
|-------------------|------------------|--|
| HSPJP02250 | 10"/250mm | |
|-------------------|------------------|--|



250mm(10")

Size:10"/250mm
Black finish and polish
Packed by PP hanger



Black finish and Polish

| Unit | PACK /QTY | Qty/Ctn |
|------|-----------|---------|
| PCS | 6 | 36 |

Insulated combination pliers

| | | |
|------------------|-----------------|--|
| HICP28188 | 7"/180mm | |
|------------------|-----------------|--|



180mm(7")

Size:7"/180mm
Black finish and polish
Insulated handle
Stand high pressure:1000V
Packed by PP hanger



| Unit | PACK /QTY | Qty/Ctn |
|------|-----------|---------|
| PCS | 6 | 36 |

Insulated combination pliers

| | | |
|------------------|-----------------|--|
| HICP28208 | 8"/200mm | |
|------------------|-----------------|--|



200mm(8")

Size:8"/200mm
Black finish and polish
Insulated handle
Stand high pressure:1000V
Packed by PP hanger



| Unit | PACK /QTY | Qty/Ctn |
|------|-----------|---------|
| PCS | 6 | 36 |

Insulated high leverage diagonal cutting pliers

| | | |
|---------------------|-----------------|--|
| HIHLDCP28160 | 6"/160mm | |
|---------------------|-----------------|--|



160mm(6")

Size:6"/160mm
Black finish and polish
Insulated handle
Stand high pressure:1000V
Packed by PP hanger



| Unit | PACK /QTY | Qty/Ctn |
|------|-----------|---------|
| PCS | 6 | 36 |

Insulated heavy-duty diagonal cutting pliers

| | | |
|--------------------|-----------------|--|
| HIHDCP28188 | 7"/180mm | |
|--------------------|-----------------|--|



180mm(7")

Size:7"/180mm
Black finish and polish
Insulated handle
Stand high pressure:1000V
Packed by PP hanger



| Unit | PACK /QTY | Qty/Ctn |
|------|-----------|---------|
| PCS | 6 | 36 |

Insulated long nose pliers

| | | |
|-------------------|-----------------|--|
| HILNP28168 | 6"/160mm | |
|-------------------|-----------------|--|



160mm(6")

Size:6"/160mm
Black finish and polish
Insulated handle
Stand high pressure:1000V
Packed by PP hanger



| Unit | PACK /QTY | Qty/Ctn |
|------|-----------|---------|
| PCS | 6 | 36 |

Insulated long nose pliers

| | | |
|-------------------|-----------------|--|
| HILNP28208 | 8"/200mm | |
|-------------------|-----------------|--|



200mm(8")

Size:8"/200mm
Black finish and polish
Insulated handle
Stand high pressure:1000V
Packed by PP hanger



| Unit | PACK /QTY | Qty/Ctn |
|------|-----------|---------|
| PCS | 6 | 36 |

Insulated cable cutter

| | | |
|-------------------|-----------------|--|
| HICCB28160 | 6"/160mm | |
|-------------------|-----------------|--|



160mm(6")

Size:6"/160mm
Black finish and polish
Insulated handle
Stand high pressure:1000V
Packed by PP hanger



| Unit | PACK /QTY | Qty/Ctn |
|------|-----------|---------|
| PCS | 6 | 36 |

Insulated pump pliers

| | | |
|------------------|------------------|--|
| HIPP28250 | 10"/250mm | |
|------------------|------------------|--|



250mm(10")

Size:10"/250mm
Max clamping open:40mm
Black finish and polish
Insulated handle
Stand high pressure:1000V
Packed by PP hanger



| Unit | PACK /QTY | Qty/Ctn |
|------|-----------|---------|
| PCS | 6 | 36 |

3 Pcs insulated pliers set

| | | |
|-------------------|-------------|--|
| HIKPS28318 | 3PCS | |
|-------------------|-------------|--|



**160mm(6")
160mm(6")
200mm(8")**

Size:
8" Insulated combination pliers
6" Insulated long nose pliers
6" Insulated diagonal cutting pliers
Cr-V, black finish and polish
Stand high pressure:1000V
Packed by PP hanger



| Unit | PACK /QTY | Qty/Ctn |
|------|-----------|---------|
| SET | 5 | 20 |

Curved jaw locking plier

HCJLW0110 10"

Cr-V
Size: 10"
HRC52-HRC60
Nickel plated
Packed by half double blister



Unit: PCS, PACK / QTY: 5, Qty/Ctn: 30

Straight jaw plier

HSJP0210 10"

Cr-V
Size: 10"
HRC52-HRC60
Nickel plated
Packed by half double blister

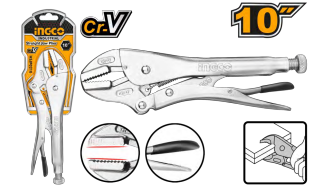

Unit: PCS, PACK / QTY: 5, Qty/Ctn: 30

Chain clamp locking plier

HCLP0210 10"

Carbon steel
Size: 10"
Chain size: 18.5"/470mm
Nickel plated
Weight: 700g
Same function as HCLP0110
Packed by color box

Carbon-steel Chain Size: 18.5"



Unit: PCS, PACK / QTY: 5, Qty/Ctn: 20

Welding plier

HWP0210 10"

Carbon steel
Size: 10"
Nickel plated
Weight: 592g
Same function as HWP0110
Packed by plastic hanger

Carbon-steel 10"

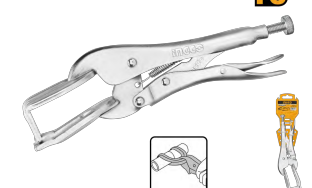

Unit: PCS, PACK / QTY: 6, Qty/Ctn: 36

Long nose locking plier

HLNP0209 9"

Carbon steel
Size: 9"
HRC38-HRC48
Nickel plated
Packed by half double blister

Carbon-steel 9"

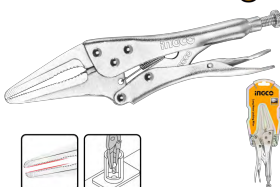

Unit: PCS, PACK / QTY: 5, Qty/Ctn: 30

C-clamp locking plier

HCCLW0211 11"

Carbon steel
Size: 11"
Weight: 710g
Nickel plated
Same function as HCCLW0111
Packed by plastic hanger

Carbon-steel 11"

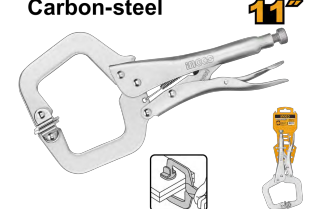

Unit: PCS, PACK / QTY: 5, Qty/Ctn: 20

Automatic wire stripper

HWSP102418 3 in 1

3 in 1 multi-function
Stripping, cutting and crimping
Stripping wires range: 10AWG-24AWG (0.2-6mm²)
Cutting function: Copper and aluminum wires
Crimping function:
Crimp the insulated terminals: 0.5-6mm² (10-22 AWG);
Crimp the non-insulated terminals: 0.5-6mm² (4-22 AWG);
Crimp the ignition terminals: 7-8mm²
Durable and comfortable handle
Packed by sliding card

210mm(8-1/4")



Unit: PCS, PACK / QTY: 12, Qty/Ctn: 48

Wire stripper

HWSP101 10"/250mm

Size: 10"/254mm
With sharp edge for cutting wire
With push down wire function
With wire stripping function
Can strip six kinds of wire size
Can cut five kinds of copper screw size
Packed by sliding card

254mm(10")



Unit: PCS, PACK / QTY: 12, Qty/Ctn: 72

Modular plug crimper

HMPCN2468R 4P,6P,8P

Modular Plug Crimper
Used for crimping terminals of network line and telephone line
Crimping range: 4P, 6P, 8P
Length: 8"
Design of labor-saving ratchet
Three functions: Crimping, Stripping, Cutting
Unique Design PVC handle
Packing by blister card

Crimping range: 4P/6P/8P 200mm(8")



Unit: PCS, PACK / QTY: 6, Qty/Ctn: 36

4 Pcs circlip pliers set

HCCPS26180 4Pcs

180mm(7")
4PCS/SET

4Pcs circlip plier set
2Pcs of 180°, 2 pcs of 90°
Size: 7"/180mm
Carbon steel
Packed by canvas bag

More Stronger



Unit: SET, PACK / QTY: 5, Qty/Ctn: 30

Electrician's scissors

HES0187 178mm/7"

Size:178mm(7")
Material: stainless steel
Unique design handle
Blade with teeth
Sand blast surface
Packed by sliding card

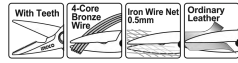

| Unit | PACK /QTY | Qty/Ctn |
|------|-----------|---------|
| PCS | 12 | 72 |

Pipe wrench

HPW0808 200mm/8"

Size:8"(200mm)
Max clamping diameter:27mm
Mobile jaw drop-forged with high quality carbon steel
Inactivate treatment
Body material:ductile cast iron
Black finish and polish
Solid rivet
Packed by paper card



| Unit | PACK /QTY | Qty/Ctn |
|------|-----------|---------|
| PCS | 6 | 36 |

Pipe wrench

HPW0810 250mm/10"

Size:10"(250mm)
Max clamping diameter:34mm
Mobile jaw drop-forged with high quality carbon steel
Inactivate treatment
Body material:ductile cast iron
Black finish and polish
Solid rivet
Packed by paper card



| Unit | PACK /QTY | Qty/Ctn |
|------|-----------|---------|
| PCS | 6 | 24 |

Pipe wrench

HPW0812 300mm/12"

Size:12" (300mm)
Max clamping diameter:42mm
Mobile jaw drop-forged with high quality carbon steel
Inactivate treatment
Body material:ductile cast iron
Black finish and polish
Solid rivet
Packed by paper card



| Unit | PACK /QTY | Qty/Ctn |
|------|-----------|---------|
| PCS | 3 | 18 |

Pipe wrench

HPW0814 350mm/14"

Size:14" (350mm)
Max clamping diameter:50mm
Mobile jaw drop-forged with high quality carbon steel
Inactivate treatment
Body material:ductile cast iron
Black finish and polish
Solid rivet
Packed by paper card



| Unit | PACK /QTY | Qty/Ctn |
|------|-----------|---------|
| PCS | 3 | 12 |

Pipe wrench

HPW0818 450mm/18"

Size:18" (450mm)
Max clamping diameter:60mm
Mobile jaw drop-forged with high quality carbon steel
Inactivate treatment
Body material:ductile cast iron
Black finish and polish
Solid rivet
Packed by paper card



| Unit | PACK /QTY | Qty/Ctn |
|------|-----------|---------|
| PCS | 2 | 10 |

Pipe wrench

HPW0824 24"

Size:24"
Max clamping diameter:76mm
Mobile jaw drop-forged with high quality carbon steel
Inactivate treatment
Body material:ductile cast iron
Black finish and polish
Solid rivet
Packed by paper card



| Unit | PACK /QTY | Qty/Ctn |
|------|-----------|---------|
| PCS | | 4 |

Pipe wrench

HPW0836 36"

Size:36"
Max clamping diameter:85mm
Mobile jaw drop-forged with high quality carbon steel
Inactivate treatment
Body material:ductile cast iron
Black finish and polish
Solid rivet
Packed by paper card



| Unit | PACK /QTY | Qty/Ctn |
|------|-----------|---------|
| PCS | | 3 |

Pipe wrench

HPW0848 48"

Size:48"
Max clamping diameter:110mm
Mobile jaw drop-forged with high quality carbon steel
Inactivate treatment
Body material:ductile cast iron
Black finish and polish
Solid rivet
Packed by paper card



| Unit | PACK /QTY | Qty/Ctn |
|------|-----------|---------|
| PCS | | 2 |

Bolt cutter

HBC0812 12"

Size:12"
Cr-V blade
Black finish and polish
TPR two color handle
Packed by paper card



| Unit | PACK /QTY | Qty/Ctn |
|------|-----------|---------|
| PCS | | 20 |

Bolt cutter

HBC0830 750mm/30"

Size:30"
Cr-V blade
Black finish and polish
TPR two color handle
Packed by paper card

CrV 750mm(30")
Ø13mm



Comfortable Rubber Handle

| Unit | PACK /QTY | Qty/Ctn |
|------|-----------|---------|
| PCS | | 4 |

Heavy duty cable cutter

HHCCB0210 250mm/10"

Heavy duty cable cutter
Size:10"/250mm
Black finish and polish
55# Carbon steel
Packed by half double blister

250mm(10")
Ø13mm



Copper And Aluminum

| Unit | PACK /QTY | Qty/Ctn |
|------|-----------|---------|
| PCS | 6 | 36 |

PVC pipe cutter

HPC0442 3-42mm

Length:230mm
Cutting diameter:3-42mm
Auto-open function
Packed by double blister

Automatic Open
3-42mm Cutting Range



4Cr13

| Unit | PACK /QTY | Qty/Ctn |
|------|-----------|---------|
| PCS | 4 | 24 |

Pipe cutter

HPC0232 3-32mm

Copper and aluminum pipe cutter
Cutting diameter:3-32mm
With high Quality blade
Aluminium knob
Packed by sliding card

3-32mm Cutting Range



Cr15

| Unit | PACK /QTY | Qty/Ctn |
|------|-----------|---------|
| PCS | 12 | 48 |

6 Pcs screwdriver set

HKSD0628 Cr-V

6 pcs screwdriver set new design handle
Material: CR-V
Round blade
1pcs SL5.5*5*75
1pcs SL5.5*5*100
1pcs SL6.5*6*150
1pcs PH1*5*75
1pcs PH1*5*100
1pcs PH2*6*150
Packed by PP hanger

6PCS/SET



| Unit | PACK /QTY | Qty/Ctn |
|------|-----------|---------|
| SET | 5 | 20 |

9 Pcs screwdriver set

HKSD0928 Cr-V

9 Pcs screwdriver set
New design handle
Material: CR-V
Round blade
1pcs SL6.5*6*38
1pcs SL3.5*3*75
1pcs SL4.0*4*100
1pcs SL5.5*5*100
1pcs SL6.5*6*125
1pcs PH0*3*75
1pcs PH2*6*38
1pcs PH1*5*100
1pcs PH2*6*125
Packed by PP hanger

9PCS/SET



SUPER SELECT

| Unit | PACK /QTY | Qty/Ctn |
|------|-----------|---------|
| SET | 5 | 20 |

10 Pcs screwdriver set

HKSD1028 Cr-V

10 pcs screwdriver set
new design handle
Material: CR-V
Round blade
1pcs SL3.0*3*75
1pcs SL4.0*4*100
1pcs SL5.5*5*125
1pcs SL6.5*6*150
1pcs SL8.0*8*200
1pcs SL6.5*6*38
1pcs PH0*3*60
1pcs PH1*5*80
1pcs PH2*6*100
1pcs PH3*8*150

10PCS/SET



| Unit | PACK /QTY | Qty/Ctn |
|------|-----------|---------|
| SET | 5 | 10 |

6 Pcs insulated screwdriver set

HKISD0608 1000V

6 PCS Insulated Screwdriver Set
SL3.0*75
SL4.0*100
SL6.5*150
PH0*60
PH1*80
PH2*100
new design handle
Use Aluminum frame
with 4pcs Screw and 4pcs Screw Plug
Round shank
1000V,VDE+GS Certification
Packed by double blister

6PCS/SET



EN IEC60900 1000V

| Unit | PACK /QTY | Qty/Ctn |
|------|-----------|---------|
| SET | 6 | 24 |

6 In 1 screwdriver set

AKISD0608 6 in 1

6 IN 1 Screwdriver set
Unique design Handle
2 pcs two-way bit:
6.35*65mm,PH1+SL5
8.00*75mm,PH2+SL6
2pcs socket: 6mm, 8mm
Material:CR-V
With 1pcs interchangeable box
Packed by Display color box

6IN1



| Unit | PACK /QTY | Qty/Ctn |
|------|-----------|---------|
| SET | 18 | 72 |

9 Pcs interchangeable screwdriver set

AKISD0901 9Pcs

Interchangeable screwdriver set
Include:
3pcs SL3X65 SL5X65 SL6X65
3pcs PH0X65 PH1X65 PH2X65
1pcs 5X65 tack remover
1pcs 3X65 scratch awl
Material: CR-V
with 1pcs Unique design Interchangeable Handle
Packed by plastic box

8 IN 1



| Unit | PACK /QTY | Qty/Ctn |
|------|-----------|---------|
| SET | 12 | 48 |

7 Pcs precision screwdriver set

HKSD0718 7Pcs

7PCS precision screwdriver set new design handle, New plastic box
 Include:
 SL2.0*50, SL2.5*50, SL3.0*50, PH00*50, PH0*50, T6*50, T8*50
 Material: CR-V
 Ergonomic comfort-grip handle
 Packed by plastic box

7PCS/SET



| Unit | PACK /QTY | Qty/Ctn |
|------|-----------|---------|
| SET | 6 | 120 |

32 Pcs precision screwdriver set

HKSD0348 32Pcs

32PCS precision screwdriver set
 1Pcs unique design handle
 1Pcs 4X60mm bits holder
 30PCS 4X28mm bits:
 SL1.5,SL2,SL2.5,SL3,SL3.5,SL4,PH000,PH00,P
 H0,PH1,T4,T5,T6,T7,T8,T9,T10,T15,T20,H0.9,H1
 .3,H1.5,H2,H2.5,H3,H4,Y2,U2.6,Five Star0.8.
 Five Star1.2 Five Star0.8, Five Star1.2 is suitable
 for iPhone and iPad
 Packed by plastic box

32PCS/SET



| Unit | PACK /QTY | Qty/Ctn |
|------|-----------|---------|
| SET | 10 | 120 |

13 In 1 ratchet screwdriver set

AKISD1208 13 in 1

13 IN 1 Ratchet Screwdriver set
 Include:
 1 Pcs Unique design ratchet handle
 Folding handle, high quality ratchet
 12 Pcs 6.35*25mm screwdriver bits
 Size: SL4,SL5,SL6,SL7, PH0, PH1,PH2,PH3,PZ0,PZ1,PZ2,PZ3
 Material: CR-V
 Packed by display color box

13IN1



| Unit | PACK /QTY | Qty/Ctn |
|------|-----------|---------|
| SET | 12 | 48 |

55 Pcs screwdriver bits set

HKSD0558 55Pcs

55 Pcs screwdriver set
 Include:
 21Pcs 6.35X25mm screwdriver bits: SL4 SL5
 SL6 PH1 PH2 PH2 PH2 PH3 PZ1 PZ2 PZ3 T10
 T15 T20 T25 T30 T40 H3 H4 H5 H6
 20Pcs 4X28mm precision screwdriver bits:
 SL1.5 SL2 SL2.5 SL3 PH000 PH00 PH0 PH1 T6
 T7 T8 T9 T10 T15 T20 H1.5 H2.0 H2.5 H3.0 H4.0
 1Pcs 4-6mm(25mm)bits adaptor
 9Pcs 1/4"X20.5mm socket:4mm 5mm 6mm 7mm
 8mm 9mm 10mm 11mm 12mm
 1Pcs 4X60mm bits holder
 1Pcs 6.35X50mm bits holder
 1Pcs Unique design ratchet handle

55PCS/SET



| Unit | PACK /QTY | Qty/Ctn |
|------|-----------|---------|
| SET | 6 | 24 |

26 Pcs screwdriver bit set

HKSD0268 26Pcs

26 PCS screwdriver bit set
 Include:
 1pcs unique design Ratchet Holder
 18pcs 65mm Screwdriver bit PH0, PH1, PH2,
 PH3, PZ1, PZ2, PZ3, SL3, SL4, SL5,
 SL6, SL7, T10, T15, T20, T25, T27, T30
 6pcs Power sleeve:5mm, 6mm, 7mm, 8mm,
 9mm, 10mm,Material: CR-V
 1pcs pouch
 Color box for presentation
 Packed by double blister

26PCS/SET



| Unit | PACK /QTY | Qty/Ctn |
|------|-----------|---------|
| SET | 6 | 24 |

7 Pcs hand tools set

HKTH10807 7Pcs

7Pcs Handtools Set
 Include:
 1 Pcs 7" Combination Pliers
 1 Pcs Test Pencil (Test voltage: 100-500VAC)
 1 Pcs 6" Adjustable Wrench
 1 Pcs 9mm Snap-off blade knife
 1 Pcs SL5.5x100 Screwdriver
 1 Pcs PH1x100 Screwdriver
 1 Pcs 3M Steel measuring tape
 Packed by Double Blister

7PCS/SET



| Unit | PACK /QTY | Qty/Ctn |
|------|-----------|---------|
| SET | 6 | 24 |

120 Pcs hand tools set

HKTHP21201 120Pcs

120 Pcs HandTools Set
 Include:
 1 Pcs 8Oz Claw hammer
 1 Pcs 7" Combination Pliers
 1 Pcs 6" Long nose pliers
 1 Pcs SL5.5*100 Screwdriver
 1 Pcs PH1*100 Screwdriver
 1 Pcs Test Pencil(test volte : 100-500V AC)
 1 Pcs 8" Adjustable Wrench
 1 Pcs 3M Steel measuring tape
 1 Pcs Mini Hacksaw frame
 9 Pcs Hex key 1.5-2-2.5-3-4-5-6-8-10MM
 20Pcs screwdriver bits
 Size: SL3 SL4 SL5 SL6 PH0 PH1 PH2 PH3 PZ0

120PCS/SET



| Unit | PACK /QTY | Qty/Ctn |
|------|-----------|---------|
| SET | 4 | 4 |

9 Pcs insulated hand tools set

HKTV01H091 9Pcs

9 Pcs Insulated hand tools set
 Include:
 1 Pcs 8" Insulated Combination Pliers
 1 Pcs 6" Insulated Diagonal Cutting Pliers
 1 Pcs 8" Insulated Long Nose Pliers
 1 Pcs PH1x80mm Insulation screwdriver
 1 Pcs PH2x100mm Insulation screwdriver
 1 Pcs SL4.0x100mm Insulation screwdriver
 1 Pcs SL5.5x125mm Insulation screwdriver
 1 Pcs PH0x60mm Insulation screwdriver
 1 Pcs Test Pencil (Test voltage: 100-500VAC)
 Packed by stackable plastic box

9PCS/SET



| Unit | PACK /QTY | Qty/Ctn |
|------|-----------|---------|
| SET | 5 | 10 |

10 Pcs Insulated hand tools set

HKTV01S101 10Pcs

10 Pcs Insulated hand tools set
 Include:
 1 Pcs SL3.0x75mm screwdriver
 1 Pcs SL4.0x100mm screwdriver
 1 Pcs SL5.5x125mm screwdriver
 1 Pcs SL6.5x150mm screwdriver
 1 Pcs PH0x60mm screwdriver
 1 Pcs PH1x80mm screwdriver
 1 Pcs PH2x100mm screwdriver
 1 Pcs PZ1x80mm screwdriver
 1 Pcs PZ2x100mm screwdriver
 1 Pcs Test Pencil (Test voltage: 100-500VAC)
 Packed by stackable plastic box

10PCS/SET



| Unit | PACK /QTY | Qty/Ctn |
|------|-----------|---------|
| SET | 5 | 10 |

7 Pcs insulated nut screwdriver set

HKISD0701 1000V

7 Pcs insulated nut screwdriver set
 1000V, VDE/GS certification
 Material: 50BV30
 Include:
 6x125mm 7x125mm 8x125mm 9x125mm
 10x125mm 11x125mm 12x125mm
 Packed by double blister

7PCS/SET



| Unit | PACK /QTY | Qty/Ctn |
|------|-----------|---------|
| SET | 5 | 20 |

6 Pcs insulated precision screwdriver set

HKIPSD0601 1000V

6Pcs insulated precision screwdriver set
1000V, VDE/GS certification
Material: S2
Include:
1.5X0.23x50mm;
2.0X0.40x50mm;
2.5X0.40x50mm;
3.0X0.50x50mm;
PH00x50mm;
PH0x50mm;
Packed by canvas bag

EN IEC60900 1000V **6PCS/SET**



| Unit | PACK /QTY | Qty/Ctn |
|------|-----------|---------|
| SET | 12 | 48 |

Insulated adjustable wrench

HIADW081 1000V

Insulated adjustable wrench
1000V, VDE/GS certification
Size: 8"/200mm
Manufactured according to EN60900
Material: chrome vanadium material
Chrome plated surface
Packed by blister card

EN IEC60900 1000V **200mm(8")**

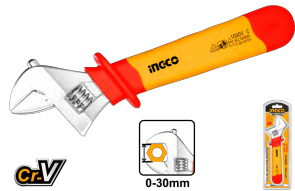

| Unit | PACK /QTY | Qty/Ctn |
|------|-----------|---------|
| PCS | 6 | 36 |

Insulated adjustable wrench

HIADW101 1000V

Insulated adjustable wrench
1000V, VDE/GS certification
Size: 10"/250mm
Manufactured according to EN60900
Material: chrome vanadium material
Chrome plated surface
Packed by blister card

EN IEC60900 1000V **250mm(10")**

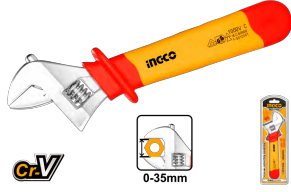

| Unit | PACK /QTY | Qty/Ctn |
|------|-----------|---------|
| PCS | 6 | 24 |

1/2" Insulated ratchet wrench

HIRTH121 1000V

Insulated ratchet wrench
1000V, VDE/GS certification
Size: 1/2" 36T
Length: 250mm
Material: Cr-V+Cr-Mo
Manufactured according to EN60900
Packed by double blister

EN IEC60900 1000V **1/2"**



| Unit | PACK /QTY | Qty/Ctn |
|------|-----------|---------|
| PCS | 10 | 20 |

Insulated dismantling knife

HIDCK1851 1000V

Insulated dismantling knife
1000V, VDE/GS certification
Size: 50x185mm
Manufactured according to EN60900
Stainless steel blade
Packed by blister card

EN IEC60900 1000V **50x185mm**



| Unit | PACK /QTY | Qty/Ctn |
|------|-----------|---------|
| PCS | 12 | 72 |

45 Pcs 1/4" socket set

HKTS14451 45Pcs

45PCS 1/4" Socket set
Include:
1Pcs 1/4" Ratchet wrench,45T
13Pcs 1/4"Dr Socket:4-4.5-5-5.5-6-7-8-9-10-11-12-13-14mm
1Pcs 1/4" Dr. Universal joint
2Pcs 1/4"Dr Extension Bar: 50mm & 100mm
1Pcs 1/4"150mm Spinner handle
20Pcs Screwdriver bits:PH1-PH2-PH3-PZ1-PZ2-PZ3-SL4-SL5-SL6-H1.5-H2-H3-H4-H5-H6-T10-T15-T20-T25-T30
1Pcs Screwdriver Bits holder
1Pcs 1/4"150mm Flexible extension bar
1Pcs 1/4"114mm Sliding T bar

EN IEC60900 1000V **45PCS/SET**



| Unit | PACK /QTY | Qty/Ctn |
|------|-----------|---------|
| SET | 12 | 6 |

25 Pcs 1/2" socket set

HKTS12251 25Pcs

25Pcs 1/2" Socket set
Include:
1Pcs 1/2"Dr Ratchet wrench,45T
18Pcs 1/2"Dr Socket: 10-11-12-13-14-15-16-17-18-19-20-21-22-23-24-27-30-32mm
1Pcs 1/2"Dr Universal Joint
2Pcs 1/2"Dr Extension Bar: 125mm & 250mm
2Pcs Spark Plug Socket: 16mm & 21mm
1Pcs 1/2"250mm Sliding T bar
Material: 50BV30
Heat treated
Packed by BMC

EN IEC60900 1000V **25PCS/SET**



| Unit | PACK /QTY | Qty/Ctn |
|------|-----------|---------|
| SET | 4 | 4 |

94 Pcs 1/4" & 1/2" socket set

HKTS42941 94Pcs

94Pcs 1/4"+1/2" Socket set
Include:
18Pcs 1/2"DR Socket:10-11-12-13-14-15-16-17-18-19-20-21-22-23-24-27-30-32mm
4Pcs 1/2"DR 77mm(L) Deep socket: 14-15-17-19mm
13Pcs 1/4"DR Socket:4-4.5-5-5.5-6-7-8-9-10-11-12-13-14mm
8Pcs 1/4"DR 50mm(L) Deep socket:6-7-8-9-10-11-12-13mm
2PCS Ratchet wrench: 1/4" and 1/2"Dr 45T
17Pcs 1/4" x 32(L) bits Socket:Hex:3-4-5-6mm Star: T8-T10-T15-T20-T25-T30 SL:4-5-5-7mm,PH1,PH2,PZ1,PZ2

EN IEC60900 1000V **94PCS/SET**



| Unit | PACK /QTY | Qty/Ctn |
|------|-----------|---------|
| SET | 2 | 2 |

24 Pcs 1/2" socket set

HKTS0243 24Pcs

24 Pcs 1/2" socket set
Include:
18 Pcs 1/2"DR. Cr-V Sockets: 10,11,12,13,14,15,16,17,18,19,20,21,22,23,24,27,30,32mm
2 Pcs 1/2"DR. Extension bar: 125mm&250mm
1 Pcs 1/2"DR. Sliding T-bar : 250mm
1 Pcs 1/2"DR. Universal joint
1 Pcs 1/2"DR. Speeder handle
1 Pcs 1/2"DR. Quick ratchet handle
Material:Cr-V(50BV30)
Heat treated
Chromed plated
Packed by metal box

EN IEC60900 1000V **24PCS/SET**



| Unit | PACK /QTY | Qty/Ctn |
|------|-----------|---------|
| SET | 4 | 4 |

Roller cabinet

HDC02071P 0

Roller cabinet
With 7 pcs drawers
Overall size:680*458*802mm
Overall with casters size:680*458*945mm
Casters size:5"2"
Thickness of cabinet:0.6-0.8mm
Thickness of drawer:0.6mm
With 1 pcs 570*410*48mm drawer
With 3 pcs 570*410*74.5mm drawer
With 2 pcs 570*410*100.5mm drawer
With 1 pcs 570*410*153.5mm drawer
Ball bearing drawer
Packed by carton box

7 Drawers



| Unit | PACK /QTY | Qty/Ctn |
|------|-----------|---------|
| PCS | 1 | 1 |

Roller cabinet

HDTC01042 **0**

Roller cabinet
With 4 pcs drawers
Overall size:765*465*812mm
Overall with casters size:765*465*976mm
Casters size:5"2"
Thickness of cabinet:0.8-1.0mm
Thickness of drawer:0.7mm
With 4 pcs 536*410*74.5mm drawer
Panel area: 560*420*395mm
With central locking system
Ball bearing drawer
Anti-shock protection
Packed by pallet

**4 Drawers
With 1 Panel Area**

| Unit | PACK /QTY | Qty/Ctn |
|------|-----------|---------|
| PCS | | 1 |

Tool box

HTB03 **495x200x290mm**

Size:404*200*205mm
3 Layers
Steel thickness: 0.6-0.8mm
Packed by label

404x200x205mm **3 Layers**

| Unit | PACK /QTY | Qty/Ctn |
|------|-----------|---------|
| PCS | | 1 |

Tool box

HTB02 **495x200x290mm**

Size:495*200*290mm
3 Layers
Steel thickness: 0.6~0.8mm
Packed by label

495x200x290mm **3 Layers**

| Unit | PACK /QTY | Qty/Ctn |
|------|-----------|---------|
| PCS | | 1 |

Plastic tool box

PBX1402 **14"**

14" Plastic Tool Box
Size : 356mm(14")*168mm (6.6") *150mm(6.3")
Material: PP
weight: 740g
Max Load : 10KG
Metal buckle
High-strength Handle
Upper cover with three storage areas
Upper cover with scale function
Contains 1Pcs plastic tray
Packed by label

14" 356x168x150mm
Weight:740g

METAL BUCKLE

| Unit | PACK /QTY | Qty/Ctn |
|------|-----------|---------|
| PCS | | 8 |

Plastic tool box

PBX1702 **17"**

17" Plastic Tool Box
Size : 436mm(17")*220mm (8.7") *205mm(8")
Material: PP
Weight: 1430g
Max Load : 15KG
Metal buckle
High-strength Handle
Upper cover with three storage areas
Upper cover with scale function
Contains 1Pcs plastic tray
Packed by label

17" 436x220x205mm
Weight:1430g

METAL BUCKLE

| Unit | PACK /QTY | Qty/Ctn |
|------|-----------|---------|
| PCS | | 8 |

Tools bag

HTBG06 **16"**

Size: 16"
25Pcs pockets for tools
Material: 600D polyester
Max load: 20kg
Reinforced plastic base for durability
Internal pockets for additional storage capacity
Adjustable shoulder strap included
Packed by paper card

16"

**With 25 Pockets
Max Load 20 kgs**

| Unit | PACK /QTY | Qty/Ctn |
|------|-----------|---------|
| PCS | 2 | 4 |

Tools bag

HTBP02031 **600D polyester**

Size: 2 Pcs L26*W23cm 1 Pcs L15*W13cm
Adjustable belt (92-127cm)
14 Pcs pockets
2 Pcs hammer holders
Max load: 10kg
Material: 600D polyester
Various pockets for tools
Packed by paper card

3PCS/SET

**With 14 Pockets
Max Load 10 kgs**

| Unit | PACK /QTY | Qty/Ctn |
|------|-----------|---------|
| PCS | 10 | 20 |

Tools bag

HTBP05021 **0**

Tool bag
Material: 600D polyeste and EVA
With two plier holders, three screwdriver bags and one tape strap holder
Riveted for industrial strength with galvanised washers both top and bottom
Found for VDE products especially
Packed by paper card

320x280mm

| Unit | PACK /QTY | Qty/Ctn |
|------|-----------|---------|
| PCS | 20 | 40 |

Tools backpack

HBP0101 **20kg**

Size: L34* W17*H45cm
With 1 Pcs handle bag inside
Max load: 8kg
Material: polyester oxford 600D
Rigid frame for easy opening and access Internal
External pockets for additional storage capacity
Packed by paper card

340x170x450mm
18"x13.8"x8.8"

Max Load 8 kgs

| Unit | PACK /QTY | Qty/Ctn |
|------|-----------|---------|
| PCS | | 8 |

G clamp

HGC0103 **3"**

Size:3"
Body malleable cast iron
T-shaped thread
Packed by paper card

75mm(3")

| Unit | PACK /QTY | Qty/Ctn |
|------|-----------|---------|
| PCS | 6 | 24 |

G clamp

HGC0104 4"

INDUSTRIAL

100mm(4")

Size:4"/100mm
Body malleable cast iron
T-shaped thread
Packed by paper card



| Unit | PACK /QTY | Qty/Ctn |
|------|-----------|---------|
| PCS | 6 | 24 |

G clamp

HGC0105 5"

INDUSTRIAL

125mm(5")

Size:5"/125mm
Body malleable cast iron
T-shaped thread
Packed by paper card



| Unit | PACK /QTY | Qty/Ctn |
|------|-----------|---------|
| PCS | 4 | 16 |

G clamp

HGC0106 6"

INDUSTRIAL

150mm(6")

Size:6"/150mm
Body malleable cast iron
T-shaped thread
Packed by paper card



| Unit | PACK /QTY | Qty/Ctn |
|------|-----------|---------|
| PCS | 4 | 16 |

G clamp

HGC0108 8"

INDUSTRIAL

200mm(8")

Size:8"
Body malleable cast iron
T-shaped thread
Packed by paper card



| Unit | PACK /QTY | Qty/Ctn |
|------|-----------|---------|
| PCS | 4 | 8 |

Quick bar clamp

HQBC01601 63x150mm

INDUSTRIAL

150mm(6")

60kgs

Clamp size:63x150mm
Max clamp force:60KGS
Thickness and width of iron ruler:5X18mm
Packed by label



| Unit | PACK /QTY | Qty/Ctn |
|------|-----------|---------|
| PCS | | 12 |

Quick bar clamp

HQBC01602 63x300mm

INDUSTRIAL

300mm(12")

60kgs

Clamp size:63x300mm
Max clamp force:60KGS
Thickness and width of iron ruler:5X18mm
Packed by label

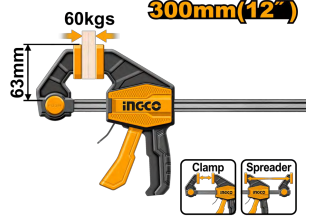

| Unit | PACK /QTY | Qty/Ctn |
|------|-----------|---------|
| PCS | | 12 |

Quick bar clamp

HQBC01603 63x450mm

INDUSTRIAL

450mm(18")

60kgs

Clamp size:63x450mm
Max clamp force:60KGS
Thickness and width of iron ruler:5X18mm
Packed by label



| Unit | PACK /QTY | Qty/Ctn |
|------|-----------|---------|
| PCS | | 12 |

Two jaws puller

HGP08023 3"

INDUSTRIAL

3"

Size:3"
2Jaws,Maxforce:2000KG
material: Cr-v,heat treated
surface treatment: chrome-plated
range of application:
A=80MM,L1=40MM,L2=44MM
Packed by carton box

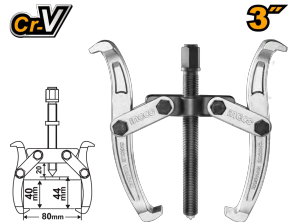

| Unit | PACK /QTY | Qty/Ctn |
|------|-----------|---------|
| PCS | | 20 |

Two jaws puller

HGP08024 4"

INDUSTRIAL

4"

Size:4"
2Jaws,Maxforce:3000KG
material: Cr-v,heat treated
surface treatment: chrome-plated
range of application:
A=115MM,A1=125MM,L1=40MM,L2=90MM,L3=38MM,L4=60MM
Packed by carton box

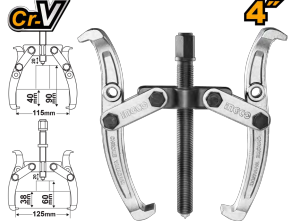

| Unit | PACK /QTY | Qty/Ctn |
|------|-----------|---------|
| PCS | | 10 |

Two jaws puller

HGP08026 6"

INDUSTRIAL

6"

Size:6"
2Jaws,Maxforce:5000KG
material: Cr-v,heat treated
surface treatment: chrome-plated
range of application:
A=160MM,A1=155MM,L1=50MM,L2=140MM,L3=50MM,L4=105MM
Packed by carton box

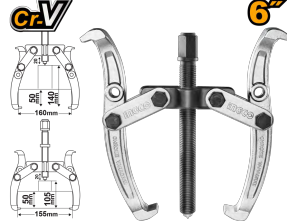

| Unit | PACK /QTY | Qty/Ctn |
|------|-----------|---------|
| PCS | | 6 |

Three jaws puller

HGP08033 **3"**

Size:3"
3Jaws,Maxforce:3000KG
material: Cr-v,heat treated
surface treatment: chrome-plated
range of application:
A=75MM,L1=40MM,L2=47MM
Packed by carton box

INDUSTRIAL

| Unit | PACK /QTY | Qty/Ctn |
|------|-----------|---------|
| PCS | | 20 |

Three jaws puller

HGP08034 **4"**

Size:4"
3Jaws,Maxforce:4000KG
material: Cr-v,heat treated
surface treatment: chrome-plated
range of application:
A=120MM,A1=125MM,L1=40MM,L2=87MM,L3=38MM,L4=60MM
Packed by carton box

INDUSTRIAL

| Unit | PACK /QTY | Qty/Ctn |
|------|-----------|---------|
| PCS | | 10 |

Three jaws puller

HGP08036 **6"**

Size:6"
3Jaws,Maxforce:6000KG
material: Cr-v,heat treated
surface treatment: chrome-plated
range of application:
A=175MM,A1=170MM,L1=50MM,L2=135MM,L3=50MM,L4=95MM
Packed by carton box

INDUSTRIAL

| Unit | PACK /QTY | Qty/Ctn |
|------|-----------|---------|
| PCS | | 6 |

Bench vice

HBV084 **4"**

100mm(4")

Swivel base Size: 4"
Weight:6.7kg
Max clamping force:1300KGS
With anvil
Packed by carton box

INDUSTRIAL

| Unit | PACK /QTY | Qty/Ctn |
|------|-----------|---------|
| PCS | | 1 |

Ductile Cast Iron

Bench vice

HBV086 **6"**

150mm(6")

Swivel base Size: 6"
Weight:11.2kg
Max clamping force:1600KGS
With anvil
Packed by carton box

INDUSTRIAL

| Unit | PACK /QTY | Qty/Ctn |
|------|-----------|---------|
| PCS | | 1 |

Ductile Cast Iron

Bench vice

HBV088 **8"**

200mm(8")

Swivel base Size: 8"
Weight:21kg
Max clamping force:2500KGS
With anvil
Packed by carton box

INDUSTRIAL

| Unit | PACK /QTY | Qty/Ctn |
|------|-----------|---------|
| PCS | | 1 |

Ductile Cast Iron

Multi-purpose bench vice

HBV085 **5"**

125mm(5")

Swivel base Size: 5"
Weight:19.5kg
Max clamping force:2000KGS
With anvil
Packed by carton box

INDUSTRIAL

| Unit | PACK /QTY | Qty/Ctn |
|------|-----------|---------|
| PCS | | 1 |

Ductile Cast Iron

4 Pcs wood chisel set

HKTWC0401 **Cr-V**

4PCS/SET

4 pcs Wood Chisel Set
Width:6mm,12mm,19mm,25mm
Length:140mm
Wood Chisel,Cr-V
Packed by Sliding card

INDUSTRIAL

| Unit | PACK /QTY | Qty/Ctn |
|------|-----------|---------|
| SET | 4 | 16 |

Cold chisel

HCCL851916 **305mm**

40Cr **19x16x305mm**
3/4"x5/8"x12"

Unique design Handle
Size:19mm*16mm*305mm
Material:40Cr
Heat treatment,limpid Powder coating
NEW Style handle
Packed by plastic hanger

INDUSTRIAL

| Unit | PACK /QTY | Qty/Ctn |
|------|-----------|---------|
| PCS | 6 | 24 |

Cold chisel

HCCL852519 **305mm**

40Cr **25x19x305mm**
1"x3/4"x12"

Unique design Handle
Size:25mm*19mm*305mm
Material:40Cr
Heat treatment,limpid Powder coating
NEW Style handle
Packed by plastic hanger

INDUSTRIAL

| Unit | PACK /QTY | Qty/Ctn |
|------|-----------|---------|
| PCS | 6 | 24 |

Wrecking bar

HWBA01242 **24"**

INDUSTRIAL

600x30x16mm
24"x1-1/5"x16/25"

Size(A*B*C):24"(600mm)*1-1/5"(30mm)
*16/25"(16.0mm)
Oval shank with notch(30°,68°)
Packed by label

| Unit | PACK /QTY | Qty/Ctn |
|------|-----------|---------|
| PCS | | 6 |

Wrecking bar

HWBA01482 **48"**

INDUSTRIAL

1200x30x16mm
48"x1-1/5"x16/25"

Size(A*B*C):48"(1200mm)*1-1/5"(30mm)
*16/25"(16.0mm)
Oval shank with notch(30°,68°)
Packed by label

| Unit | PACK /QTY | Qty/Ctn |
|------|-----------|---------|
| PCS | | 6 |

Heavy duty staple gun

HSG1404 **4-14mm**

INDUSTRIAL

HEAVY-DUTY 4-14mm

Heavy duty staple gun
Wire:1.2mm
Crown:10.6mm or 11.3mm
Length: 4-14mm
With 1000PCS nails
Matched with Staple items:
STS0208,STS0210 and STS0212
Packed by double blister

| Unit | PACK /QTY | Qty/Ctn |
|------|-----------|---------|
| PCS | 5 | 20 |

Mini hacksaw frame

MHHF1501 **150mm/6"**

150mm(6")

Mini Hacksaw
Size: 150mm (6")
With 1 pcs blade
Packed in paper card

| Unit | PACK /QTY | Qty/Ctn |
|------|-----------|---------|
| PCS | 24 | 144 |

Mini hacksaw blade

MHSB1521 **150mm/6"**

150mm(6") **10PCS/SET**

Size: 150mm (6")
Number of teeth: 24T
10Pcs/Set
Material: 65Mn
Suitable for item MHHF1501 MHHF1502
MHHF1503
Packed by Plastic bag

| Unit | PACK /QTY | Qty/Ctn |
|------|-----------|---------|
| SET | 24 | 288 |

Hacksaw frame

HHFS3068 **300mm/12"**

300mm(12")

Size:300mm/12"
handle hacksaw frame, adjustable
With Soft grip
Including 1pcs 65Mn saw blade
Packed by paper card

| Unit | PACK /QTY | Qty/Ctn |
|------|-----------|---------|
| PCS | 6 | 24 |

Hacksaw frame

HHF3008 **300mm/12"**

INDUSTRIAL

300mm(12")

Size:300mm/12"
Heavy duty steel frame
Aluminum + TPR handle,Strong and Comfortable
Adjustable tension
Quick-release blade changing mechanism
Including 1pcs 65Mn blade
Packed by paper card

| Unit | PACK /QTY | Qty/Ctn |
|------|-----------|---------|
| PCS | 6 | 24 |

Hacksaw frame

HHF3088 **300mm/12"**

INDUSTRIAL

300mm(12")

Unique design INDUSTRIAL Hacksaw frame
Size:300mm/12"
Heavy duty frame
Aluminum + ABS + TPR handle,Strong and Comfortable
Adjustable tension
Quick-release blade changing mechanism
Including 1pcs 65Mn saw blade
Packed by paper card

| Unit | PACK /QTY | Qty/Ctn |
|------|-----------|---------|
| PCS | 6 | 24 |

Hand saw

HHAS08500 **500mm/20"**

500mm(20")

Size: 20"(500mm)
Thickness: 0.9mm, 7TPI
Material:65Mn
With teeth protector
Heat treatment
Packed by paper card

| Unit | PACK /QTY | Qty/Ctn |
|------|-----------|---------|
| PCS | 6 | 24 |

Hand saw

HHAS08550 **550mm/22"**

550mm(22")

Size: 22"(550mm)
Thickness: 0.9mm, 7TPI
Material:65Mn
With teeth protector
Heat treatment
Packed by paper card

| Unit | PACK /QTY | Qty/Ctn |
|------|-----------|---------|
| PCS | 6 | 24 |

Hand saw

HHAS28400 400mm/16"

Size:16"/400mm
Material: Taiwan SK5
7TPI,heat treatment teeth
Triple teeth(Precision ground teeth 3 edges)
Two color soft handle
Fast cut and long life
Packed by Color sleeve



400mm(16")

SK5

Long life fast CUT 7TPI Wood PVC

| Unit | PACK /QTY | Qty/Ctn |
|------|-----------|---------|
| PCS | 6 | 24 |

Hand saw

HHAS28500 500mm/20"

Size:20"/500mm
Material: Taiwan SK5
7TPI,heat treatment teeth
Triple teeth(Precision ground teeth 3 edges)
Two color soft handle
Fast cut and long life
Packed by Color sleeve



500mm(20")

SK5

Long life fast CUT 7TPI Wood PVC

| Unit | PACK /QTY | Qty/Ctn |
|------|-----------|---------|
| PCS | 6 | 24 |

Snap-off blade knife

HKNS28035 18x100mm

Blade Size:18mmx100mm
With 3 pcs SK5 blades(HKNSB112)
With flat push button
Length:167mm
Packed by sliding card



18x100mm

3PCS

SK5

SUPER SELECT

| Unit | PACK /QTY | Qty/Ctn |
|------|-----------|---------|
| PCS | 12 | 96 |

Utility knife

HUK6118 61x19mm

Blade size:61x19mm
Size:180x45mm
SK5 blade
With 5 blades(HUKB61001)
Pack by double blister



19x61mm

Aluminum Alloy

5PCS SK5 Blades

| Unit | PACK /QTY | Qty/Ctn |
|------|-----------|---------|
| PCS | 6 | 72 |

Utility knife

HUK615 61x19mm

Zinc alloy body
65MN Tool carrier
With 1 pcs SK5 blades (HUKB61001)
Auto-Lock
Blade:61mm(L)x19mm(W)x0.6(T)
Weight:110g
Packed by sliding card



19x61mm

Zinc Alloy

| Unit | PACK /QTY | Qty/Ctn |
|------|-----------|---------|
| PCS | 12 | 72 |

10 Pcs 18mm knife blades set

HKNSB112 18x100mm

10Pcs/Set
Size: 18X100mm
Suitable for item HKNS16001/ HKNS16518/
HKNS16618/ /HKNS16538/ HKNS1808/
HKNS28035/HKNS1807
Packed by plastic box



10PCS/BOX

18x100mm

SK5

SUPER SELECT

| Unit | PACK /QTY | Qty/Ctn |
|------|-----------|---------|
| SET | 20 | 120 |

10 Pcs utility knife blades set

HUKB61001 61x19mm

10Pcs/Set
Size: 61X19mm
Suitable for item HUK6128/HUK6118/HUK618/
HUK615/HUK6236/HUK6288
Packed by plastic box



10PCS/BOX

19x61mm

SK5

SUPER SELECT

| Unit | PACK /QTY | Qty/Ctn |
|------|-----------|---------|
| SET | 20 | 200 |

Foldable multi-function tool

HFMFT0115 15 Funct

Stainless steel handle with soft rubber grip
Stainless steel components
Foldable, easy to carry
Includes 1pcs nylon belt pouch
Overall size: 155mm
closed size: 100mm
With 15 Function

- 1.Flat nose Pliers
- 2.Regular pliers
- 3.Wire Cutters
- 4.Sharp knife
- 5.3# Screwdriver
- 6.Bottle opener
- 7.5# Screwdriver
- 8.7# Screwdriver
- 9.Serrated knife
- 10.Wood Saw
- 11.Multi-functional Hook
- 12.Hook remover
- 13.Phillips Screwdriver
- 14.Can Opener

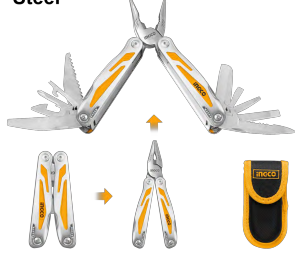

Stainless Steel

15 FUNCTION

| Unit | PACK /QTY | Qty/Ctn |
|------|-----------|---------|
| PCS | 6 | 36 |

Aviation snip

HTSN0110S 250mm/10"

Unique design two tone soft handle
Aviation snip(Straight)
Length:250mm (10")
Max.cutting thickness:
Carbon steel ≤1.2mm
Stainless steel ≤0.7mm
Packed by half double blister



250mm(10")

Stainless steel 0.7mm
Carbon steel 1.2mm

| Unit | PACK /QTY | Qty/Ctn |
|------|-----------|---------|
| PCS | 5 | 40 |

Long straight aviation snip

HTSN0112S 300mm/12"

Aviation snip(Straight)
Length:300mm (12")
Unique design two tone soft handle
Cutting plastic or rubber or 0.5mm brass wire net
Packed by half double blister



300mm(12")

Plastic or rubber
Copper wire net

| Unit | PACK /QTY | Qty/Ctn |
|------|-----------|---------|
| PCS | 5 | 40 |

3 Pcs aviation snip set

HTSNK0110 250mm/10"

3PCS/SET
250mm(10")

Two tone soft handle
3Pcs aviation snip (Left, Straight, Right)
Length: 250mm (10")
Max. cutting thickness:
Carbon steel ≤1.2mm
Stainless steel ≤0.7mm
Packed by double blister

Stainless steel 0.7mm
Carbon steel 1.2mm

| Unit | PACK /QTY | Qty/Ctn |
|------|-----------|---------|
| SET | 4 | 16 |

3 Pcs wood file set

HKTFW0308 200mm

3Pcs File Set 200mm(8")

Length: 8"/200mm
Flat wood file 1pcs
Half round wood file 1pcs
Round wood file 1pcs
Packed by double blister

Flat
Half round
Round

| Unit | PACK /QTY | Qty/Ctn |
|------|-----------|---------|
| SET | 10 | 20 |

Grease gun

GRG015001 400CC / 14oz

Heavy-Duty Grease Gun
Taiwan Quality
Capacity: 400CC / 14Oz
Loading way: 14Oz Cartridge / 400CC Bulk
Working Pressure: 4500psi
Burst Pressure: 10000psi
Material: 1.2mm Steel tube + Aluminum-Cast
Standard Accessory:
1pcs 12" High Pressure Flexible Nylon Hose
1pcs Metallic Bend Spout
Packed by color box

400cc

Key components made in Taiwan Top quality in the world

| Unit | PACK /QTY | Qty/Ctn |
|------|-----------|---------|
| PCS | | 10 |

Putty trowel

HPUT08080 80mm(3")

75mm(3")

Size: 75mm(3")
stainless steel
Heat treatment
Fine polished
Double color plastic handle
Packed by label

INGCO Unique Design
Blade thickness

| Unit | PACK /QTY | Qty/Ctn |
|------|-----------|---------|
| PCS | 12 | 120 |

Bricklaying trowel

HBT618 150mm/6"

150mm(6")

Size: 6"/150mm(plastic handle)
Diameter of connecting rod: 9.5mm
unique design handle
Packed by label

| Unit | PACK /QTY | Qty/Ctn |
|------|-----------|---------|
| PCS | 10 | 60 |

5 Pcs steel file set

HKTFS0508 200mm

5Pcs File Set 200mm(8")

Length: 8"/200mm, T12 Steel
Flat steel file 1pcs
Half round steel file 1pcs
Round steel file 1pcs
Triangle steel file 1pcs
Square steel file 1pcs
Packed by double blister

Flat
Triangle
Half round
Round
Square

| Unit | PACK /QTY | Qty/Ctn |
|------|-----------|---------|
| SET | 5 | 10 |

Caulking gun

HCG1709 9"

360° Rotary 230mm(9")

9" caulking gun
Strong aluminum handle
Length: 230mm
With rotary function
Thickness: 1.8mm
Diameter: 55mm
Smooth rod: 8.0mm
Packed by paper card

Suitable for:

| Unit | PACK /QTY | Qty/Ctn |
|------|-----------|---------|
| PCS | 12 | 24 |

Putty trowel

HPUT08060 60mm(2.5")

63mm(2.5")

Size: 63mm(2.5")
stainless steel
Heat treatment
Fine polished
Double color plastic handle
Packed by label

INGCO Unique Design
Blade thickness

| Unit | PACK /QTY | Qty/Ctn |
|------|-----------|---------|
| PCS | 12 | 120 |

Putty trowel

HPUT08100 100mm(4")

100mm(4")

Size: 100mm(4")
stainless steel
Heat treatment
Fine polished
Double color plastic handle
Packed by label

INGCO Unique Design
Blade thickness

| Unit | PACK /QTY | Qty/Ctn |
|------|-----------|---------|
| PCS | 12 | 120 |

Bricklaying trowel

HBT718 180mm/7"

180mm(7")

Size: 7"/180mm(plastic handle)
Diameter of connecting rod: 9.5mm
unique design handle
Packed by label

| Unit | PACK /QTY | Qty/Ctn |
|------|-----------|---------|
| PCS | 12 | 48 |

Bricklaying trowel

HBT818 **200mm/8"**

200mm(8")

Size: 8"/200mm(plastic handle)
Diameter of connecting rod:9.5mm
unique design handle
Packed by label



| Unit | PACK /QTY | Qty/Ctn |
|------|-----------|---------|
| PCS | 12 | 48 |

Plastering trowel

HPT28138 **280x130mm**

280x130mm

Plastering trowel
Size:280x130mm
Unique design handle
Packed by plastic bag



| Unit | PACK /QTY | Qty/Ctn |
|------|-----------|---------|
| PCS | 10 | 40 |

Plastering trowel with teeth

HPTT28138 **280x130mm**

280x130mm

Plastering trowel with teeth
Size:280x130mm
Teeth:10*10mm
Unique design handle
Packed by plastic bag



| Unit | PACK /QTY | Qty/Ctn |
|------|-----------|---------|
| PCS | 10 | 40 |

Paint brush

CHPTB68701 **1"**

25mm(1")

Bristle Length: 45mm
Thickness: 10mm

Width:1"
For Oil-Based paint
Unique design plastic handle
Bristle length: 45mm
Thickness: 10mm
Packed by label

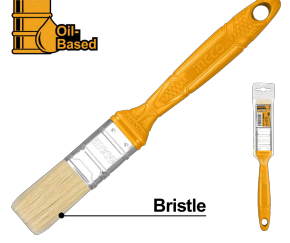

| Unit | PACK /QTY | Qty/Ctn |
|------|-----------|---------|
| PCS | 12 | 360 |

Paint brush

CHPTB68702 **2"**

50mm(2")

Bristle Length: 51mm
Thickness: 11mm

Width:2"
For Oil-Based paint
Unique design plastic handle
Bristle length: 51mm
Thickness: 11mm
Packed by label



| Unit | PACK /QTY | Qty/Ctn |
|------|-----------|---------|
| PCS | 12 | 240 |

Paint brush

CHPTB68703 **3"**

75mm(3")

Bristle Length: 57mm
Thickness: 12mm

Width:3"
For Oil-Based paint
Unique design plastic handle
Bristle length: 57mm
Thickness: 12mm
Packed by label

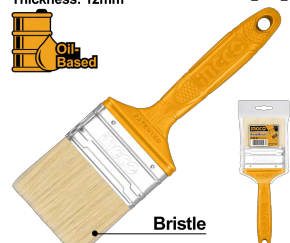

| Unit | PACK /QTY | Qty/Ctn |
|------|-----------|---------|
| PCS | 12 | 120 |

Paint brush

CHPTB68704 **4"**

100mm(4")

Bristle Length: 57mm
Thickness: 14mm

Width:4"
For Oil-Based paint
Unique design plastic handle
Bristle length: 57mm
Thickness: 14mm
Packed by label

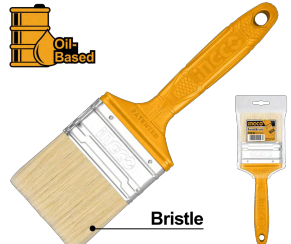

| Unit | PACK /QTY | Qty/Ctn |
|------|-----------|---------|
| PCS | 12 | 120 |

Mini cylinder brush(Inner wall)

HRHT061001D **100mm/4"**

100mm(4")

Material: Micro fibre
Size: 100mm/4"
Fibre height:12mm
Suitable for inner wall
6mm central shank
With 1pcs roller cover
Match with unique handle
Packed by plastic bag



| Unit | PACK /QTY | Qty/Ctn |
|------|-----------|---------|
| PCS | 50 | 100 |

Cylinder brush(Inner wall)

HRHT282302 **230mm/9"**

230mm(9")

Material:Acrylic
Size:230mm/9"
Fibre height:12mm
Suitable for inner wall
6mm central shank
With 1pcs roller cover
With 4pcs assistant shank
Packed by plastic bag



| Unit | PACK /QTY | Qty/Ctn |
|------|-----------|---------|
| PCS | 20 | 40 |

Cylinder brush(Inner wall)

HRHT042301D **230mm/9"**

230mm(9")

Material: Micro fibre
Size:230mm/9"
Fibre height: 12mm
Suitable for inner wall
6mm central shank
With 1pcs roller cover
With 4pcs assistant shank
Match with unique handle
Packed by plastic bag



| Unit | PACK /QTY | Qty/Ctn |
|------|-----------|---------|
| PCS | 20 | 40 |

Cylinder brush (Inner wall)

HRHT052301 230mm/9"

Material: Acrylic
 Size: 230mm/9"
 Fibre height: 7mm
 Suitable for inner wall
 6mm central shank
 With 1 pcs roller cover
 With 4 pcs assistant shank
 Match with unique handle
 Packed by plastic bag



Acrylic
 7mm
 Inner Wall +
 Smooth Surface

| Unit | PACK /QTY | Qty/Ctn |
|------|-----------|---------|
| PCS | 20 | 40 |

Cylinder brush (Outer wall)

HRHT092551 255mm/10"

Material: Acrylic
 Size: 255mm/10"
 Super bigger size
 Fibre height: 22mm
 Suitable for outer wall
 8mm central shank
 Match with unique handle
 With 1 pcs roller cover
 Packed by plastic bag



Acrylic
 22mm
 Outer Wall +
 Coarse Surface

| Unit | PACK /QTY | Qty/Ctn |
|------|-----------|---------|
| PCS | 20 | 40 |

Telescoping cylinder brush

HRHT442302T 230mm/9"

Material: Micro fibre
 Size: 230mm/9"
 Fibre height: 12mm
 Suitable for inner wall
 Mini length: 440mm
 Max length: 880mm
 With 1 pcs roller cover
 With 4 pcs assistant shank
 8mm central shank
 With 3 parts telescoping aluminum tube
 Packed by plastic bag



Micro Fibre
 12mm
 Inner Wall +
 Middle Coarse Surface

| Unit | PACK /QTY | Qty/Ctn |
|------|-----------|---------|
| PCS | 12 | 24 |

Cylinder brush 11 in 1 set (Inner wall)

HKTCB121001 100mm/4"

Material: Acrylic + polyester foam
 Size: 100mm/4"
 Suitable for inner wall and smooth surface
 6mm central shank
 With 5 pcs 12mm acrylic mini rollers
 With 5 pcs polyester foam rollers
 Packed by double blister



100mm(4") 11PCS/SET
Polyester Foam **Acrylic**
 10mm
 Inner Wall +
 Smooth Surface
 12mm
 Inner Wall +
 Middle Coarse Surface

| Unit | PACK /QTY | Qty/Ctn |
|------|-----------|---------|
| SET | 20 | 40 |

Cylinder brush 3 in 1 set (Inner wall)

HKTCB032301 3 in 1

Material: Acrylic
 Cylinder brush size: 230mm/9"
 Bigger size roller cover
 Fibre height: 12mm
 Suitable for inner wall
 6mm central shank
 With 1 pcs 10" paint tray
 With 1 pcs acrylic cylinder brush
 Paint tray size: 435x300x7.5mm
 Packed by shrink



230mm(9") 3PCS/SET
Acrylic
 12mm
 Inner Wall +
 Middle Coarse Surface
 60kg

| Unit | PACK /QTY | Qty/Ctn |
|------|-----------|---------|
| SET | | 10 |

Combination spanner set

HKSPA1088 6-19mm

8pcs combination spanner set
 Size: 6-19mm
 6mm, 8mm, 10mm, 12mm, 14mm, 15mm, 17mm, 19mm
 Fine polished
 Packed by plastic hanger



8PCS/SET

| Unit | PACK /QTY | Qty/Ctn |
|------|-----------|---------|
| SET | 5 | 10 |

Double open end spanner set

HKSPA2088 6-22mm

8pcs double open end spanner set
 Size: 6-22mm
 6x7mm, 8x9mm, 10x11mm, 12x13mm, 14x15mm, 16x17mm, 18x19mm, 20x22mm
 Fine polished
 Packed by plastic hanger



8PCS/SET

6x7mm, 8x9mm, 10x11mm, 12x13mm, 14x15mm, 16x17mm, 18x19mm, 20x22mm

| Unit | PACK /QTY | Qty/Ctn |
|------|-----------|---------|
| SET | 5 | 10 |

8 Pcs flexible ratchet spanner set

HKSPAR1083 8-19mm

8pcs Flexible Ratchet Spanner Set
 High quality Cr-Mo Ratchet
 Size: 8-19mm
 8mm, 10mm, 12mm, 13mm, 14mm, 15mm, 17mm, 19mm
 Fine polished, CR-V
 Packed by plastic hanger



8PCS/SET
 72T 180°
 Cr-Mo

8mm, 10mm, 12mm, 13mm, 14mm, 15mm, 17mm, 19mm

| Unit | PACK /QTY | Qty/Ctn |
|------|-----------|---------|
| SET | 5 | 10 |

Combination spanner set

HKSPA1143 6-32mm

12pcs combination spanner set
 Size: 6-32mm
 6mm, 8mm, 10mm, 12mm, 14mm, 17mm, 19mm, 22mm, 24mm, 27mm, 30mm, 32mm
 Fine polished
 Packed by canvas bag



12PCS/SET

6mm, 8mm, 10mm, 12mm, 14mm, 17mm, 19mm, 22mm, 24mm, 27mm, 30mm, 32mm

| Unit | PACK /QTY | Qty/Ctn |
|------|-----------|---------|
| SET | | 8 |

Double open end spanner set

HKSPA2142 6-32mm

12pcs double open end spanner set
 Size: 6-32mm
 6x7mm, 8x9mm, 10x11mm, 12x13mm, 14x15mm, 16x17mm, 18x19mm, 20x22mm, 21x23mm, 24x27mm, 25x28mm, 30x32mm
 Fine polished
 Packed by canvas bag



12PCS/SET

6x7mm, 8x9mm, 10x11mm, 12x13mm, 14x15mm, 16x17mm, 18x19mm, 20x22mm, 21x23mm, 24x27mm, 25x28mm, 30x32mm

| Unit | PACK /QTY | Qty/Ctn |
|------|-----------|---------|
| SET | | 8 |

Offset ring spanner set

HKSPA3142 6-32mm

12pcs offset ring spanner set
 Size:6-32mm
 6x7mm,8x9mm,10x11mm,12x13mm,
 14x15mm,16x17mm,18x19mm,20x22mm,21X23
 mm,24X27mm,25X28mm,30X32mm
 Fine polished
 Packed by canvas bag



12PCS/SET

| Unit | PACK /QTY | Qty/Ctn |
|------|-----------|---------|
| SET | | 8 |

6x7mm,8x9mm,10x11mm,12x13mm,14x15mm,
 16x17mm,18x19mm,20x22mm,21x23mm,
 24x27mm,25x28mm,30x32mm

Ratchet spanner set

HKSPAR1061 19-32mm

6pcs Ratchet Spanner Set
 Size:19-32mm
 19mm,22mm,24mm,27mm,30mm,32mm
 Fine polished ,CR-V
 Packed by canvas bag



6PCS/SET

| Unit | PACK /QTY | Qty/Ctn |
|------|-----------|---------|
| SET | | 4 |

19mm,22mm,24mm,27mm,30mm,
 32mm

Combination spanner

HCSPA221 22mm

Size:22mm
 Length:262mm
 Material:Cr-V
 Chrome plated,matt finish
 Packed by paper card



22mm

| Unit | PACK /QTY | Qty/Ctn |
|------|-----------|---------|
| PCS | 6 | 90 |

Combination spanner

HCSPA241 24mm

Size:24mm
 Length:287mm
 Material:Cr-V
 Chrome plated,matt finish
 Packed by paper card



24mm

| Unit | PACK /QTY | Qty/Ctn |
|------|-----------|---------|
| PCS | 6 | 60 |

Combination spanner

HCSPA271 27mm

Size:27mm
 Length:331mm
 Material:Cr-V
 Chrome plated,matt finish
 Packed by paper card



27mm

| Unit | PACK /QTY | Qty/Ctn |
|------|-----------|---------|
| PCS | 6 | 60 |

Ratchet spanner

HCSPAR211 21mm

Size:21mm
 Length: 290mm
 Material:Cr-V
 Chrome plated,matt finish
 Packed by paper card



21mm

| Unit | PACK /QTY | Qty/Ctn |
|------|-----------|---------|
| PCS | 5 | 60 |

Ratchet spanner

HCSPAR241 24mm

Size:24mm
 Length: 335mm
 Material:Cr-V
 Chrome plated,matt finish
 Packed by paper card



24mm

| Unit | PACK /QTY | Qty/Ctn |
|------|-----------|---------|
| PCS | 5 | 40 |

Ratchet spanner

HCSPAR271 27mm

Size:27mm
 Length: 359mm
 Material:Cr-V
 Chrome plated,matt finish
 Packed by paper card



27mm

| Unit | PACK /QTY | Qty/Ctn |
|------|-----------|---------|
| PCS | 5 | 30 |

Bent wrench

HBWS110808 TPR

1 PCS double open end wrench, 9-14mm,15-
 22mm
 1 PCS single open end wrench, 23-32mm
 Chrome plated
 Two color handle
 Packed by sliding card



**9-14mm+15-22mm
 23-32mm**

| Unit | PACK /QTY | Qty/Ctn |
|------|-----------|---------|
| SET | 5 | 20 |

Open Width 23-32mm Open Width 9-14mm Open Width 15-22mm

Adjustable wrench

HADW131062 150mm/6"

Length:150mm(6")
 Adjustable clamp size:0-19.2mm
 Packed by paper card



150mm(6")

| Unit | PACK /QTY | Qty/Ctn |
|------|-----------|---------|
| PCS | 10 | 120 |

45#CS 0-19mm

Adjustable wrench

HADW131082 **200mm/8"**

Length:200mm(8")
Adjustable clamp size:0-24mm
Packed by paper card

200mm(8")



45#CS 0-24mm

| Unit | PACK /QTY | Qty/Ctn |
|------|-----------|---------|
| PCS | 6 | 36 |

Adjustable wrench

HADW131102 **250mm/10"**

Length:250mm(10")
Adjustable clamp size:0-30mm
Packed by paper card

250mm(10")



45#CS 0-30mm

| Unit | PACK /QTY | Qty/Ctn |
|------|-----------|---------|
| PCS | 6 | 24 |

Adjustable wrench

HADW131122 **300mm/12"**

Length:300mm(12")
Adjustable clamp size:0-35mm
Packed by paper card

300mm(12")



45#CS 0-35mm

| Unit | PACK /QTY | Qty/Ctn |
|------|-----------|---------|
| PCS | 6 | 24 |

Adjustable wrench

HADW131068 **150mm/6"**

Length:150mm(6"),CrV
Adjustable clamp size:0-24mm
Unique design two tone soft handle
Packed by plastic hanger

150mm(6")



CrV 0-24mm

| Unit | PACK /QTY | Qty/Ctn |
|------|-----------|---------|
| PCS | 6 | 60 |

Adjustable wrench

HADW131088 **200mm/8"**

Length:200mm(8"),CrV
Adjustable clamp size:0-35mm
Unique design two tone soft handle
Packed by plastic hanger

200mm(8")



CrV 0-30mm

| Unit | PACK /QTY | Qty/Ctn |
|------|-----------|---------|
| PCS | 6 | 36 |

Adjustable wrench

HADW131108 **250mm/10"**

Length:250mm(10"),CrV
Adjustable clamp size:0-35mm
Unique design two tone soft handle
Packed by plastic hanger

250mm(10")



CrV 0-35mm

| Unit | PACK /QTY | Qty/Ctn |
|------|-----------|---------|
| PCS | 6 | 24 |

Adjustable wrench

HADW131128 **300mm/12"**

Length:300mm(12"),CrV
Adjustable clamp size:0-41mm
Unique design two tone soft handle
Packed by plastic hanger

300mm(12")



CrV 0-41mm

| Unit | PACK /QTY | Qty/Ctn |
|------|-----------|---------|
| PCS | 4 | 16 |

Hex key

HHK11091 **Cr-V**

9pcs hex key set
Material: Cr-V
Size: 1.5mm,2mm, 2.5mm, 3mm, 4mm, 5mm, 6mm, 8mm, 10mm.
Long arm
Heat treatment and chrome plate
Packed by double blister

9PCS/SET

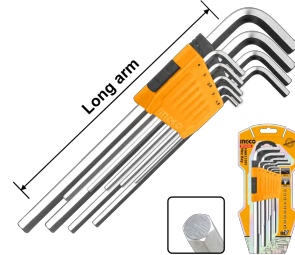

| Unit | PACK /QTY | Qty/Ctn |
|------|-----------|---------|
| SET | 6 | 48 |

Hex key

HHK11092 **Cr-V**

9pcs hex key set
Material: Cr-V
Size: 1.5mm,2mm, 2.5mm, 3mm, 4mm, 5mm, 6mm, 8mm, 10mm.
Extra-long arm
Heat treatment and chrome plate
Packed by double blister

9PCS/SET

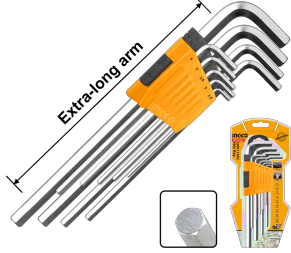

| Unit | PACK /QTY | Qty/Ctn |
|------|-----------|---------|
| SET | 6 | 48 |

Ball point hex key

HHK12091 **Cr-V**

9pcs ball point hex key set
Material: Cr-V
Size: 1.5mm,2mm, 2.5mm, 3mm, 4mm, 5mm, 6mm, 8mm, 10mm.
Long arm
Heat treatment and chrome plate
Packed by double blister

9PCS/SET



| Unit | PACK /QTY | Qty/Ctn |
|------|-----------|---------|
| SET | 6 | 48 |

6 Pcs folding nut driver set

HFND0601 Cr-V

6PCS/SET

5mm, 6mm, 8mm, 9mm, 10mm, 12mm

6 Pcs folding nut driver set
 Size: 5mm, 6mm, 8mm, 9mm, 10mm, 12mm
 Material: Cr-V+AL
 Heat treatment
 Packed by pp handle



| Unit | PACK /QTY | Qty/Ctn |
|------|-----------|---------|
| SET | 6 | 24 |

Ratchet wrench

HRTH0814 Cr-V+Cr-Mo

1/4"

Size:1/4" 45T
 Length:155mm
 Material : Cr-V+CrMo
 Packed by plastic hanger



| Unit | PACK /QTY | Qty/Ctn |
|------|-----------|---------|
| PCS | 10 | 80 |

Ratchet wrench

HRTH0838 Cr-V+Cr-Mo

3/8"

Size:3/8" 45T
 Length:200mm
 Material : Cr-V+CrMo
 Packed by plastic hanger



| Unit | PACK /QTY | Qty/Ctn |
|------|-----------|---------|
| PCS | 5 | 40 |

Ratchet wrench

HRTH0812 Cr-V+Cr-Mo

1/2"

Size:1/2" 45T
 Length:255mm
 Material : Cr-V+CrMo
 Packed by plastic hanger



| Unit | PACK /QTY | Qty/Ctn |
|------|-----------|---------|
| PCS | 5 | 20 |

Torque wrench

HPTW200N1 Cr-V+Cr-Mo

42-210N.M

1/2"

Size: 1/2"
 Length: 530mm
 Torque range: 40-200N.m
 Tolerance of torque ±4%
 Material : Cr-V+Cr-Mo
 Easy torque-adjusting design
 Packed by BMC



| Unit | PACK /QTY | Qty/Ctn |
|------|-----------|---------|
| PCS | | 6 |

Jack stand

HJS0301 3Ton

3Ton

2pcs/pair
 3Ton
 Min. height: 285mm
 Max. height:425mm
 Net weight: 6.3kg
 Large saddle,more stable
 Packed by color box



| Unit | PACK /QTY | Qty/Ctn |
|------|-----------|---------|
| PAIR | | 1 |



Steel measuring tape

HSMT26316 **3mx16mm**

Length & width:3mx16mm
With metric and inch
Double button
Unique design
Pure ABS material cover
Packed by plastic hanger



**Double Button
Continuous Marking Blade**

| Unit | PACK /QTY | Qty/Ctn |
|------|-----------|---------|
| PCS | 12 | 60 |

Steel measuring tape

HSMT26519 **5mx19mm**

Length & width:5mx19mm
Double button
With metric and inch
Unique design
Pure ABS material cover
Packed by plastic hanger



**Double Button
Continuous Marking Blade**

| Unit | PACK /QTY | Qty/Ctn |
|------|-----------|---------|
| PCS | 12 | 60 |

Steel measuring tape

HSMT08316 **3mx16mm**

Length & width:3mx16mm
Self lock function
With metric and inch
Double button
Unique design
Packed by plastic hanger



**Double Button
Self lock function
Continuous Marking Blade**

| Unit | PACK /QTY | Qty/Ctn |
|------|-----------|---------|
| PCS | 12 | 60 |

Steel measuring tape

HSMT08519 **5mx19mm**

Length & width:5mx19mm
Self lock function
With metric and inch
Double button
Unique design
Packed by plastic hanger



**Double Button
Self lock function
Continuous Marking Blade**

| Unit | PACK /QTY | Qty/Ctn |
|------|-----------|---------|
| PCS | 12 | 60 |

Steel measuring tape

HSMT08825 **8mx25mm**

Length & width:8mx25mm
Self lock function
With metric and inch
Double button
Unique design
Packed by plastic hanger



**Double Button
Self lock function
Continuous Marking Blade**

| Unit | PACK /QTY | Qty/Ctn |
|------|-----------|---------|
| PCS | 12 | 48 |

Steel measuring tape

HSMT8430 **30mx12.5mm**

3:1 Gear ratio for fast rewind
Length & width:30mx12.5mm
With metric and inch
Pure material retracting gear
With all rubber cover
Integrated handle good for using and convenient storing
Packed by color box



**3:1
Gear Ratio For Fast Rewind**

More efficient

Steel

| Unit | PACK /QTY | Qty/Ctn |
|------|-----------|---------|
| PCS | 10 | 40 |

Fibreglass measuring tape

HFMT8320 **20mx12.5mm**

3:1 Gear ratio for fast rewind
Length & width:20mx12.5mm
With metric and inch
Pure material retracting gear
With all rubber cover
Integrated handle good for using and convenient storing
Packed by color box



**3:1
Gear Ratio For Fast Rewind**

More efficient

Fibre-glass

| Unit | PACK /QTY | Qty/Ctn |
|------|-----------|---------|
| PCS | 10 | 40 |

Fibreglass measuring tape

HFMT8350 **50mx12.5mm**

3:1 Gear ratio for fast rewind
Length & width:50mx12.5mm
With metric and inch
Pure material retracting gear
With all rubber cover
Integrated handle good for using and convenient storing
Ergonomic handle
Packed by color box



**3:1
Gear Ratio For Fast Rewind**

More efficient

Fibre-glass

| Unit | PACK /QTY | Qty/Ctn |
|------|-----------|---------|
| PCS | 10 | 20 |

Spirit level

HSL18100 **100cm**

Length: 100cm
Aluminum
Aluminum thickness:1mm
Packed by color sleeve



100cm

x3 Accuracy 0.5mm/m Alu 1mm

| Unit | PACK /QTY | Qty/Ctn |
|------|-----------|---------|
| PCS | | 20 |

Spirit level

HSL08030 **30cm**

Length: 30cm
Double side milled
0.5mm/m accurate vials
Thickness:1.5mm
V-shape slot for measuring objects with round surface
Packed by color sleeve



30cm

Bottom

x3 Accuracy 0.5mm/m Alu 1.5mm

| Unit | PACK /QTY | Qty/Ctn |
|------|-----------|---------|
| PCS | | 20 |

Spirit level

HSL08040 **40cm**

40cm

Length: 40cm
Double side milled
0.5mm/m accurate vials
Thickness:1.5mm
V-shape slot for measuring objects with round surface
Packed by color sleeve



Bottom



| Unit | PACK /QTY | Qty/Ctn |
|------|-----------|---------|
| PCS | | 20 |

Spirit level

HSL08050 **50cm**

50cm

Length: 50cm
Double side milled
0.5mm/m accurate vials
Thickness:1.5mm
V-shape slot for measuring objects with round surface
Packed by color sleeve



Bottom



| Unit | PACK /QTY | Qty/Ctn |
|------|-----------|---------|
| PCS | | 20 |

Spirit level

HSL08060 **60cm**

60cm

Length: 60cm
Double side milled
0.5mm/m accurate vials
Thickness:1.5mm
V-shape slot for measuring objects with round surface
Packed by color sleeve



Bottom



| Unit | PACK /QTY | Qty/Ctn |
|------|-----------|---------|
| PCS | | 20 |

Spirit level

HSL08080 **80cm**

80cm

Length: 80cm
Double side milled
0.5mm/m accurate vials
Thickness:1.5mm
V-shape slot for measuring objects with round surface
Packed by color sleeve



Bottom



| Unit | PACK /QTY | Qty/Ctn |
|------|-----------|---------|
| PCS | | 20 |

Spirit level

HSL08120 **120cm**

120cm

Length: 120cm
Double side milled
0.5mm/m accurate vials
Thickness:1.5mm
V-shape slot for measuring objects with round surface
Packed by color sleeve



Bottom



| Unit | PACK /QTY | Qty/Ctn |
|------|-----------|---------|
| PCS | | 20 |

Spirit level with powerful magnets

HSL38030M **30cm**

30cm

Length: 30cm
Double side milled
0.5mm/m accurate vials
Thickness:1.5mm
2 Pcs powerful magnets
Double flat surfaces design
Packed by color sleeve



Bottom



| Unit | PACK /QTY | Qty/Ctn |
|------|-----------|---------|
| PCS | | 20 |

Spirit level with powerful magnets

HSL38040M **40cm**

40cm

Length: 40cm
Double side milled
0.5mm/m accurate vials
Thickness:1.5mm
2 Pcs powerful magnets
Double flat surfaces design
Packed by color sleeve



Bottom



| Unit | PACK /QTY | Qty/Ctn |
|------|-----------|---------|
| PCS | | 20 |

Spirit level With powerful magnets

HSL38060M **60cm**

60cm

Length: 60cm
Double side milled
0.5mm/m accurate vials
Thickness:1.5mm
3 Pcs powerful magnets
Double flat surfaces design
Packed by color sleeve



Bottom



| Unit | PACK /QTY | Qty/Ctn |
|------|-----------|---------|
| PCS | | 20 |

Spirit level With powerful magnets

HSL38080M **80cm**

80cm

Length: 80cm
Double side milled
0.5mm/m accurate vials
Thickness:1.5mm
4 Pcs powerful magnets
Double flat surfaces design
Packed by color sleeve



Bottom



| Unit | PACK /QTY | Qty/Ctn |
|------|-----------|---------|
| PCS | | 20 |

Spirit level With powerful magnets

HSL38100M **100cm**

100cm

Length: 100cm
Double side milled
0.5mm/m accurate vials
Thickness:1.5mm
4 Pcs powerful magnets
Double flat surfaces design
Packed by color sleeve



Bottom



| Unit | PACK /QTY | Qty/Ctn |
|------|-----------|---------|
| PCS | | 20 |

Heavy-duty mason's level

HBSL08040 40cm

Length: 40cm
 Net weight: 450 g
 Accuracy: 0.5mm/m
 Finely milled bottom surface
 Heavy-duty cast aluminum tapered body
 Shock-absorbing rubber strike pads & end caps
 To withstand trowel blows and protect the level's integrity
 Horizontal & vertical spirit bubbles
 Packed by color sleeve

40cm

INDUSTRIAL

Bottom

x2 Accuracy 0.5mm/m Shock absorbing end caps

| Unit | PACK /QTY | Qty/Ctn |
|------|-----------|---------|
| PCS | | 20 |

Test pencil

HSDT1408 100-500V

Test Voltage: AC 100-500V
 Slotted size: 3x140mm
 Packed by plastic hanger

Test voltage: AC 100-500V **3x140mm**

Neon Bulb

| Unit | PACK /QTY | Qty/Ctn |
|------|-----------|---------|
| PCS | 30 | 360 |

Vernier caliper

HVC01150 0-150mm

Range: 0-150mm
 Reading: 0.05mm
 Material: Carbon steel
 With metric and inch
 Packed by plastic box

150mm(6")

| Unit | PACK /QTY | Qty/Ctn |
|------|-----------|---------|
| PCS | 10 | 50 |

Vernier caliper

HVC01200 0-200mm

Range: 0-200mm
 Reading: 0.05mm
 Material: Carbon steel
 With metric and inch
 Packed by plastic box

200mm(8")

| Unit | PACK /QTY | Qty/Ctn |
|------|-----------|---------|
| PCS | 10 | 30 |

Digital caliper

HDCCD28150 0-150mm

Range: 0-150mm
 Reading: 0.01mm
 IP54 housing
 Battery 3V
 Metric/inch system conversion at any position
 Packed by plastic box

150mm(6") IP54

3V

| Unit | PACK /QTY | Qty/Ctn |
|------|-----------|---------|
| PCS | 10 | 50 |

Digital caliper

HDCCD28200 0-200mm

Range: 0-200mm
 Reading: 0.01mm
 IP54 housing
 Battery 3V
 Metric/inch system conversion at any position
 Packed by plastic box

200mm(8") IP54

3V

| Unit | PACK /QTY | Qty/Ctn |
|------|-----------|---------|
| PCS | 10 | 30 |

Laser distance detector

HLDD0608 0.05-60m

Measuring Range: 0.05-60m
 Measuring Accuracy: ±2.0mm
 Laser Type: 635nm, <1mW, Class 2
 Operating temp: -10°C ~ +50°C
 Function: Distance, area, volume, height
 With power off function
 With 1pcs canvas bag
 Packed by color box

0.05-60m

Reference Function Unit Back Light OFF

| Unit | PACK /QTY | Qty/Ctn |
|------|-----------|---------|
| PCS | | 20 |

Digital multimeter

DM200 2000 counts

Display :2000 counts
 LCD with backlight
 DC Voltage: 200mV/2V/20V/200V/600V
 AC Voltage: 200V/600V
 DC Current: 20mA/200mA/10A
 Resistance: 200Ω/2kΩ/20kΩ/200kΩ/2MΩ/20MΩ
 Diode test
 date hold
 Battery test
 Low battery indication
 Auto power off
 Packed by color box

CAT-III 600V

10A 600V 600V 20MΩ

| Unit | PACK /QTY | Qty/Ctn |
|------|-----------|---------|
| PCS | 10 | 40 |

Digital multimeter

DM7502 6000 counts

Display : 6000 counts true RMS
 LCD with double color backlight
 DC Voltage: 600mV/6V/60V/600V/1000V
 AC Voltage: 6V/60V/600V/750V
 DC Current: 60μA/60mA/600mA/10A
 AC Current: 60mA/600mA/10A
 Resistance: 600Ω/6kΩ/60kΩ/600kΩ/6MΩ/60MΩ
 Capacitance: 10nf/100nf/1000nf/10μF/100μF/1000μF/10mf/100mf
 Frequency: 10Hz/100Hz/1000Hz/10KHz/100KHz/1000KHz/10MHz
 Duty cycle: 1%-99%
 Non-contact voltage detection

CAT-III 1000V CAT-IV 600V

750V 1000V 10A 10A 600Ω

| Unit | PACK /QTY | Qty/Ctn |
|------|-----------|---------|
| PCS | 5 | 20 |

Digital AC clamp meter

DCM6003 6000 Counts

Display :6000 counts
 LCD with double color backlight
 AC Current: 4A/40A/400A/600A
 AC Voltage: 4V/40V/400V/600V
 DC Voltage: 400mV/4V/40V/400V/600V
 Resistance: 400Ω/4kΩ/40kΩ/400kΩ/4MΩ/40MΩ
 Capacitance: 4nf/40nf/400nf/4μF/40μF/400μF/4mf
 Non-contact voltage detection
 Diode test
 Data Hold
 Low battery indication
 Auto power off
 With flash light function
 Packed by color box

AC-600A

600A 600V 600V 40MΩ

| Unit | PACK /QTY | Qty/Ctn |
|------|-----------|---------|
| PCS | 5 | 20 |

Flashlight

HFL013AAA58 **250Lm**

250 Lumens
3AAA

Brightness:250 lumens
Irradiation distance: 160m
Use alkaline 3AAA battery
Tail light switch
Diameter/length :34mm/136mm,
Weight:104g(without battery)
Packed by double blister



LED

| Unit | PACK /QTY | Qty/Ctn |
|------|-----------|---------|
| PCS | 6 | 36 |

Flashlight

HCFL1865051 **125g**

450 Lumens

Brightness:
Max:450 lumens
Mid:150 lumens
Low:50 lumens
Use 2000mah 18650 Li-ion battery
High light 4H runtime
Low light 18H runtime
Five
switch:highlight,middlelight,lowlight,flash,SOS
Diameter/length :34mm/141mm
Net weight:125g
Packed by double blister



LED

| Unit | PACK /QTY | Qty/Ctn |
|------|-----------|---------|
| PCS | 6 | 36 |

Nitrile gloves

HNGG01 **XL**

12Pairs/Paper

Size: XL
Use for oil environment (Less oil)worker etc.
Nitrile coated palm, smooth and rough-texture palm finish.
Packed by poly bag



CE **EN388 4121X**

| Unit | PACK /QTY | Qty/Ctn |
|------|-----------|---------|
| PAIR | 12 | 120 |

Latex gloves

HGVL08-XL **XL**

1Pair/Paper

Size:XL
Use for heavy cargo handling worker, slight sharp objects carrier etc.
From pressing,longer life time than normal.
Latex gloves
Polyester seamless knitted shell.
Textured palm dip for extra grip and durability.
Packed by poly bag



CE **EN388 2131X**

| Unit | PACK /QTY | Qty/Ctn |
|------|-----------|---------|
| PAIR | 12 | 120 |

Cut-resistance gloves

HGCG01-XL **XL**

1Pair/Paper

Size:XL
Use for timber and glass cutting worker, heavy sharp objects carriers etc.
PU coated palm,flexible and good feeling.
HPPE shell,cut-resistance and abrasion.
Antistatic.
Packed by poly bag



CE **EN388 4X42C**

| Unit | PACK /QTY | Qty/Ctn |
|------|-----------|---------|
| PAIR | 12 | 120 |

Mechanic gloves

HGMG01-XL **XL**

1Pair/Paper

Size:XL
Microfibre material palm provide dexterity to utilize tools and equipments
Pack by paper hanger



CE **EN388 4X42C**

| Unit | PACK /QTY | Qty/Ctn |
|------|-----------|---------|
| PAIR | 12 | 120 |

Mechanic gloves

HGMG02-XL **XL**

1Pair/Paper

Size:XL
Microfibre material palm with PVC leather reinforced on palm enhance extreme abrasion resistance.
Rubber on back prevent hand from hazards in dark.
Pack by paper hanger



CE **EN388 2121X**

| Unit | PACK /QTY | Qty/Ctn |
|------|-----------|---------|
| PAIR | 12 | 120 |

Leather gloves

HGVC01 **10.5"**

6Pairs/Paper

Size:10.5"
Use for carriers, machining operators, garden work etc.
Cow split leather gloves
Cotton back & rubberized cuff,half lining
Packed by poly bag



CE **EN388 2121X**

Add one piece of leather more to be stonger.

| Unit | PACK /QTY | Qty/Ctn |
|------|-----------|---------|
| PAIR | 36 | 72 |

Rain coat

HRCTL031.M **M**

100% NEW PVC

Material: PVC+polyester
100% New PVC
Length: 120cm
Thickness: 0.33mm
Size:M

Waterproof. breathe freely
Two down pockets with flap
With reflective strip at back
Packed by poly bag



0.33mm Thickness

x2 Pocket

Breather Hole

| Unit | PACK /QTY | Qty/Ctn |
|------|-----------|---------|
| PCS | 5 | 20 |

Rain coat

HRCTL031.L **L**

100% NEW PVC

Material: PVC+polyester
100% New PVC
Length: 120cm
Thickness: 0.33mm
Size:L

Waterproof. breathe freely
Two down pockets with flap
With reflective strip at back
Packed by poly bag



0.33mm Thickness

x2 Pocket

Breather Hole

| Unit | PACK /QTY | Qty/Ctn |
|------|-----------|---------|
| PCS | 5 | 20 |

Rain coat

HRCTL031.XL **XL**

Material: PVC+polyester
100% New PVC
Length: 120cm
Thickness: 0.33mm
Size:XL
Waterproof, breathe freely
Two down pockets with flap
With reflective strip at back
Packed by poly bag



100% NEW PVC
INDUSTRIAL
XL

0.33mm Thickness

x2 Pocket

Breather Hole

| Unit | PACK /QTY | Qty/Ctn |
|------|-----------|---------|
| PCS | 5 | 20 |

Rain coat

HRCTL031.XXL **XXL**

Material: PVC+polyester
100% New PVC
Length: 120cm
Thickness: 0.33mm
Size:XXL
Waterproof, breathe freely
Two down pockets with flap
With reflective strip at back
Packed by poly bag



100% NEW PVC
INDUSTRIAL
XXL

0.33mm Thickness

x2 Pocket

Breather Hole

| Unit | PACK /QTY | Qty/Ctn |
|------|-----------|---------|
| PCS | 5 | 20 |

Welding mask

HHWM102 **108x50x3mm**

Viewing area: 108x50mm

Welding mask
Material:100% PP
With 1 pcs 108*50*3mm welding glass and 1 pcs protection glass
Packed by label



100% NEW PP
INDUSTRIAL

| Unit | PACK /QTY | Qty/Ctn |
|------|-----------|---------|
| PCS | 10 | 20 |

Welding mask

WM101 **108x50x3mm**

Viewing area: 108x50mm

Welding mask
Material:100% PP
Glass size:108*50*3mm, movable type glass
1 pcs clear protection glass
Packed by label



100% NEW PP
INDUSTRIAL

| Unit | PACK /QTY | Qty/Ctn |
|------|-----------|---------|
| PCS | 10 | 20 |

Auto-darkening welding helmet

AHM008 **92x42mm**

Viewing area:92x42mm
Cartridge size:110x90x9mm
Arc sensor:2
Optical class: 1/1/1/2
Light state:DIN 4
Dark state:variable shade, 9~13
Shade control:external,variable
Power ON/OFF:fully automatic
Sensitivity control:auto
UV/IR protection:DIN 16
Power supply:solar cells+2*CR2032 lithium batteries
Switching time:1/15000s,from light to dark
Dark to light (Delay) :0.1-1.0 auto



Viewing area: 92x42mm

100% NEW PP
INDUSTRIAL

Grind Function

Low Battery

| Unit | PACK /QTY | Qty/Ctn |
|------|-----------|---------|
| PCS | | 6 |

Auto-darkening welding helmet

AHM006 **100x67mm**

Optical rating: 1/1/1/1
The biggest view area: 100 x 67 mm
Sensors: 4
Light state: DIN 3
Dark state: DIN 5-9 / 9-13
UV/IR protection: up to DIN 16
Switch time (Light to dark): <0.04ms
Shade control: inside & stepless
Sensitivity control: inside & stepless
Delay control (Dark to light): inside & stepless, 0.15-0.80s



Viewing area: 100x67mm

100% NEW PP
INDUSTRIAL

180° Full View Window

HD HD PROTECT

AUTO ON/OFF Power

Low Battery

Grind Function

| Unit | PACK /QTY | Qty/Ctn |
|------|-----------|---------|
| PCS | | 6 |

Face shield

HFSPC32 **0**

Impact resistant visor
Brim protects forehead from outside injury
Headgear with adjustable knobs, with antibacterial sweatband
Packed by label



100% NEW PP
INDUSTRIAL

39x20cm

| Unit | PACK /QTY | Qty/Ctn |
|------|-----------|---------|
| PCS | | 20 |

Mesh visor

HFSPC21 **0**

Ultra clear view mesh visor
Brim protects forehead from outside injury
Headgear with adjustable knobs, with antibacterial sweatband
Packed by label



100% NEW PP
INDUSTRIAL

39x20cm
Special Cutting Grass

| Unit | PACK /QTY | Qty/Ctn |
|------|-----------|---------|
| PCS | | 20 |

Face shield

HFSPC01 **0**

Impact resistant visor
Brim protects forehead from outside injury
Headgear with adjustable knobs, with antibacterial sweatband
Packed by label



100% NEW PP
INDUSTRIAL

39x20cm

| Unit | PACK /QTY | Qty/Ctn |
|------|-----------|---------|
| PCS | | 20 |

Welding goggles

HSGW01 **PVC**

Flexible PVC body, indirect ventilation design.
Dark shade:11
Flip design with open-close locking positioning, easy to use.
Inner lenses are clear, outer lenses adopt colored inorganic glass.
Packed by poly bag



Din:11

WELDING

PC

| Unit | PACK /QTY | Qty/Ctn |
|------|-----------|---------|
| PCS | 20 | 40 |

Ratchet straps

HRSP4101 **4Tx10m**

Load:4T
Length:10m
Width:50mm
With ratchet and double J hooks
Packed by strap



50mm

4Tx10m

| Unit | PACK /QTY | Qty/Ctn |
|------|-----------|---------|
| SET | | 10 |

Assembly Line



Complete Automatic Coil Winding Machine For Motor

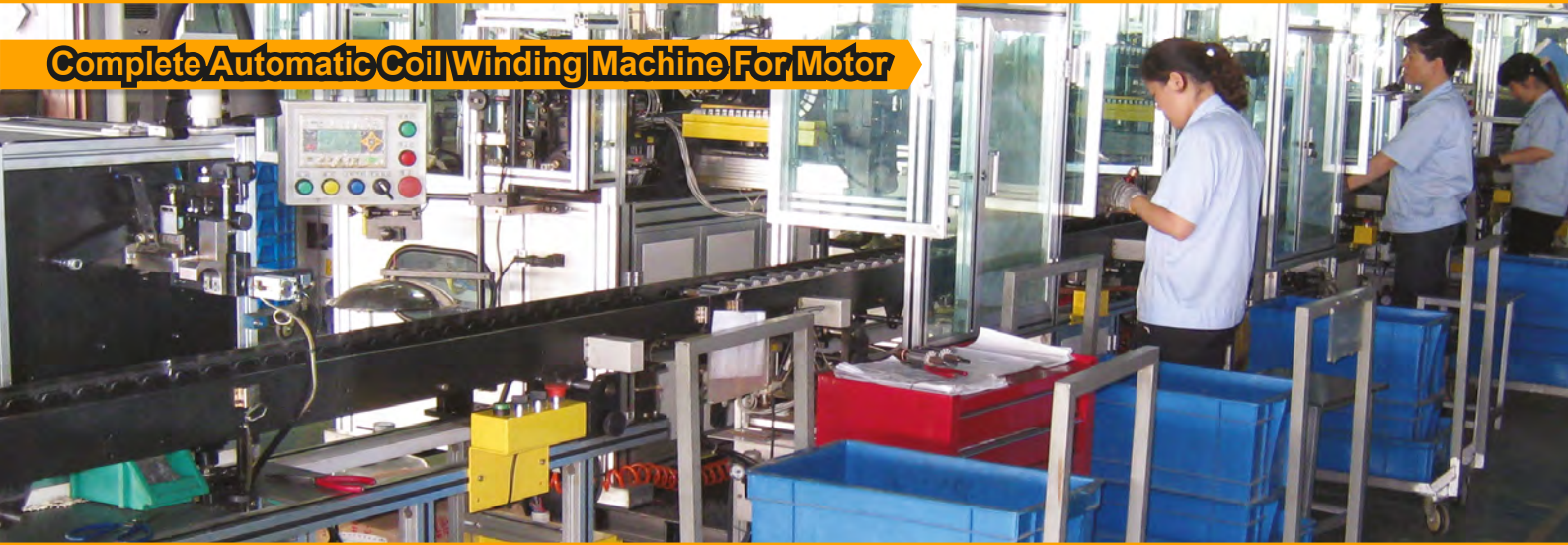

Automatic Winding Machine For Commutator And Motor

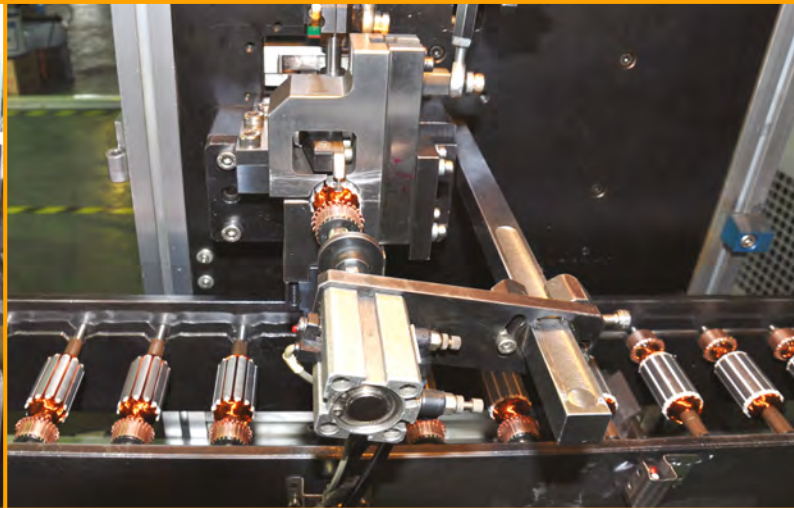

CIDL 2003
INGCO
Lithium-Ion Impact Drill
20V
INDUSTRIAL

INGCO®

Make The World In Your Hands

ALASDAF Trading Est.

Email: alasdaf@al-asdaf.com

Web side: www.alasdaf.com.sa

Tell: (+966)13-3620988 / (+966)13-3623921

Adress1: Riyadh

P.O.Box:57378 Riyadh 11574

Adress2: Jubail

P.O.Box:42 Aljubail 31951

King Fahad Street, Kingdom of Saudi Arabia

